

4.7V to 60V Input, 50mA Synchronous Step-Down Converter with Low IQ

Check for Samples: [TPS54062](#)

FEATURES

- Integrated High Side and Low Side MOSFET
- Peak Current Mode Control
- 89 μ A (typical) Operating Quiescent Current
- 100kHz to 400kHz Switching Frequency
- Synchronizes to External Clock
- Internal Slow Start
- 0.8V \pm 2% Voltage Reference
- Stable with Ceramic Output Capacitors or Low Cost Aluminum Electrolytic
- Cycle-by-Cycle Current Limit, Thermal and Frequency Fold Back Protection
- MSOP8 Package

APPLICATIONS

- Low Power Standby or Bias Voltage Supplies
- 4-20mA Current-Loop Powered Sensors
- Industrial Process Control, Metering, and Security Systems
- High Voltage Linear Regulator Replacement

DESCRIPTION

The TPS54062 device is a 60V, 50-mA, synchronous step-down converter with integrated high side and low side MOSFETs. Current mode control provides simple external compensation and flexible component selection. The non switching supply current is 89 μ A. Using the enable pin, shutdown supply current is reduced to 1.7 μ A.

Under voltage lockout is internally set at 4.5V, but can be increased using the accurate enable pin threshold. The output voltage startup ramp is controlled by the internal slow start time.

Adjustable switching frequency range allows efficiency and external component size to be optimized. Frequency fold back and thermal shutdown protects the part during an overload condition.

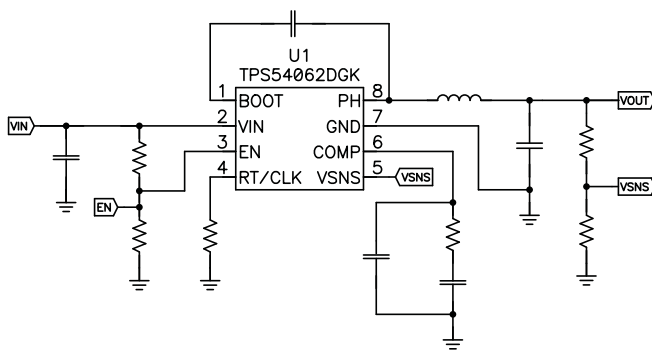
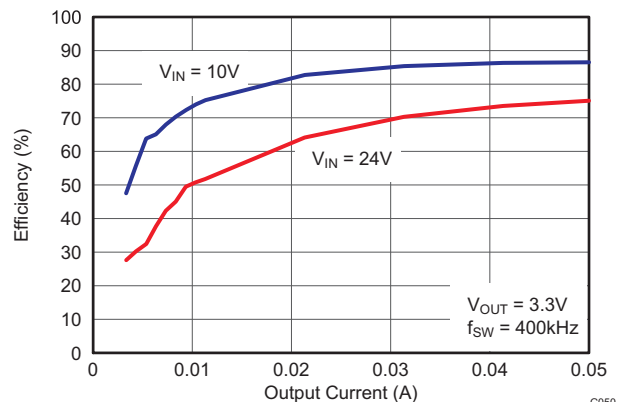
SIMPLIFIED SCHEMATIC

EFFICIENCY

G050



Please be aware that an important notice concerning availability, standard warranty, and use in critical applications of Texas Instruments semiconductor products and disclaimers thereto appears at the end of this data sheet.

SwitcherPro is a trademark of Texas Instruments.

PRODUCTION DATA information is current as of publication date. Products conform to specifications per the terms of the Texas Instruments standard warranty. Production processing does not necessarily include testing of all parameters.

Copyright © 2011, Texas Instruments Incorporated



These devices have limited built-in ESD protection. The leads should be shorted together or the device placed in conductive foam during storage or handling to prevent electrostatic damage to the MOS gates.

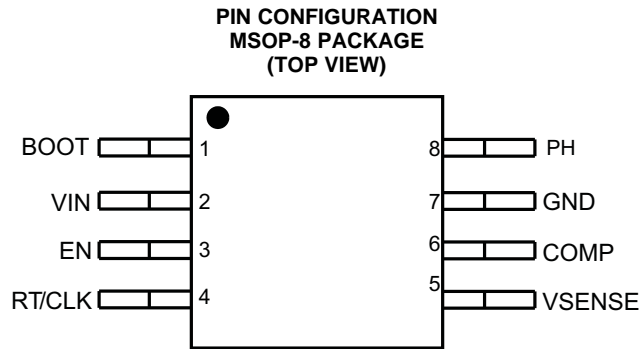

PIN FUNCTIONS

| PIN | | DESCRIPTION |
|--------|--------|--|
| NAME | NUMBER | |
| BOOT | 1 | A bootstrap capacitor is required between BOOT and PH. If the voltage on this capacitor is below the minimum required by the output device, the output is forced to switch off until the capacitor is refreshed. |
| VIN | 2 | Input supply voltage, 4.7V to 60V. |
| EN | 3 | Enable pin, internal pull-up current source. Pull below 1.14V to disable. Float to enable. Adjust the input undervoltage lockout with two resistors, see the Enable and Adjusting Undervoltage Lockout section. |
| RT/CLK | 4 | Resistor Timing and External Clock. An internal amplifier holds this pin at a fixed voltage when using an external resistor to ground to set the External Clock Input frequency. If the pin is pulled above the PLL upper threshold, a mode change occurs and the pin becomes a synchronization input. The internal amplifier is disabled and the pin is a high impedance clock input to the internal PLL. If clocking edges stop, the internal amplifier is re-enabled and the mode returns to a resistor set function. |
| VSENSE | 5 | Inverting node of the transconductance (gm) error amplifier. |
| COMP | 6 | Error amplifier output, and input to the output switch current comparator. Connect frequency compensation components to this pin. |
| GND | 7 | Ground |
| PH | 8 | The source of the internal high-side power MOSFET and drain of the internal low side MOSFET |

FUNCTIONAL BLOCK DIAGRAM

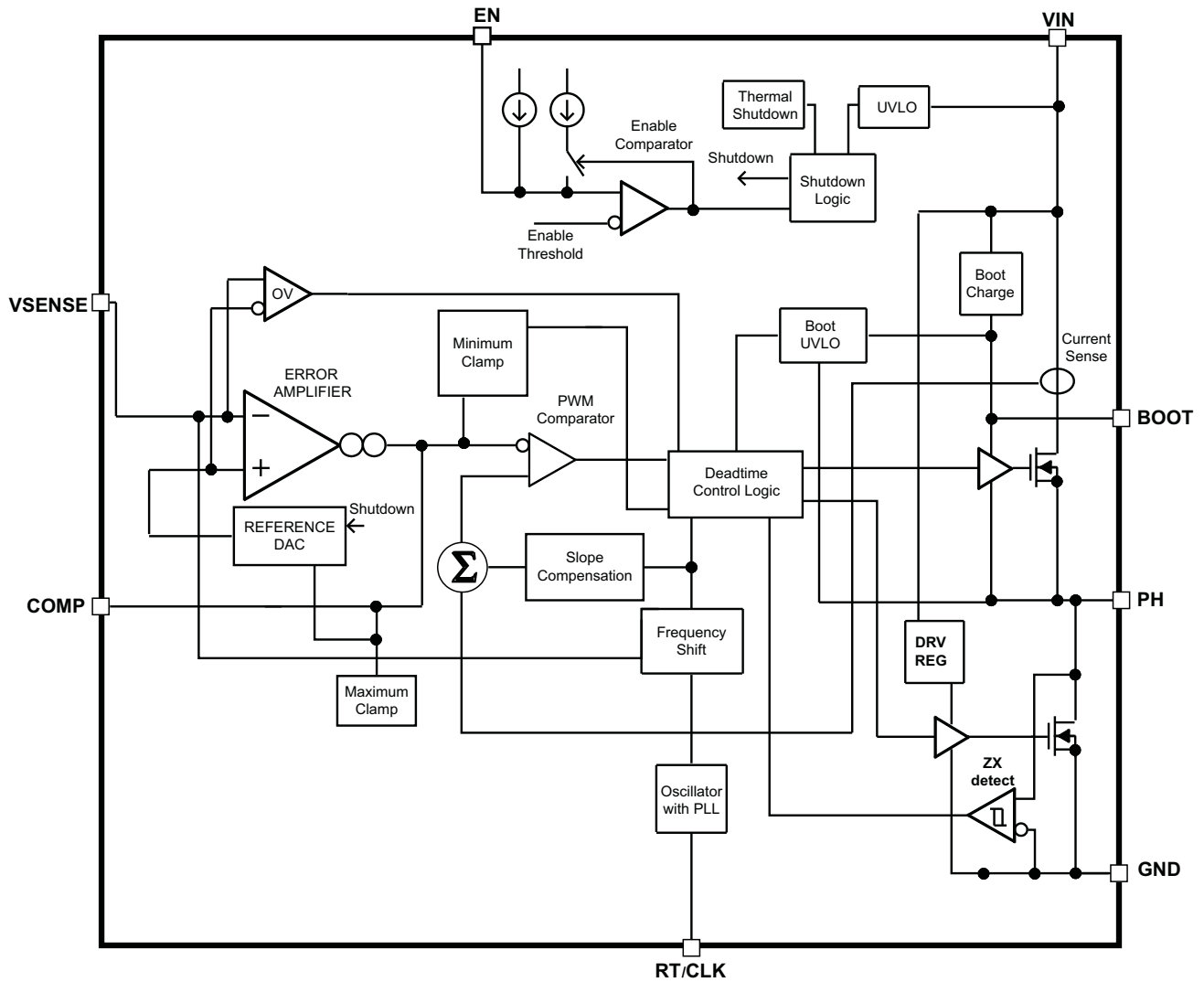

ABSOLUTE MAXIMUM RATINGS⁽¹⁾

over operating free-air temperature range (unless otherwise noted)

| | | VALUE | | UNIT |
|--------------------------------|-------------------------------------|--------------------|-----|------|
| | | MIN | MAX | |
| Voltage | VIN | -0.3 | 62 | V |
| | EN | -0.3 | 5 | V |
| | PH-BOOT | | 8 | V |
| | BOOT | | 70 | V |
| | VSENSE | -0.3 | 6 | V |
| | COMP | -0.3 | 3 | V |
| | PH | -0.6 | 62 | V |
| | PH, 10ns Transient | -2 | 62 | V |
| | RT/CLK | -0.3 | 6 | V |
| Current | VIN | Internally Limited | | A |
| | EN | | 100 | μA |
| | BOOT | | 100 | mA |
| | VSENSE | | 10 | μA |
| | COMP | | 100 | μA |
| | PH | Internally Limited | | A |
| | RT/CLK | | 200 | μA |
| Electrostatic discharge | (HBM) QSS 009-105 (JESD22-A114A) | | 2 | kV |
| | (CDM) QSS 009-147 (JESD22-C101B.01) | | 500 | V |
| Operating junction temperature | | -40 | 125 | °C |
| Storage temperature | | -65 | 150 | °C |

(1) The Absolute Maximum Ratings specified in this section will apply to all specifications of this document unless otherwise noted. These specifications will be interpreted as the conditions which may damage the device with a single occurrence.

THERMAL INFORMATION

| THERMAL METRIC ⁽¹⁾ | | TPS54062 | UNITS |
|-------------------------------|--|---------------|-------|
| | | MSOP (8-PINS) | |
| θ_{JA} | Junction-to-ambient thermal resistance | 127.1 | °C/W |
| θ_{JcTop} | Junction-to-case (top) thermal resistance | 33.4 | |
| θ_{JB} | Junction-to-board thermal resistance | 80.0 | |
| Ψ_{JT} | Junction-to-top characterization parameter | 1.0 | |
| Ψ_{JB} | Junction-to-board characterization parameter | 79.0 | |
| θ_{JcBot} | Junction-to-case (bottom) thermal resistance | n/a | |

(1) For more information about traditional and new thermal metrics, see the *IC Package Thermal Metrics* application report, [SPRA953](#).

ELECTRICAL CHARACTERISTICS⁽¹⁾

TEST CONDITIONS: $T_J = -40^{\circ}\text{C}$ to 125°C , $V_{IN} = 4.7$ To 60 V (unless otherwise noted)

| PARAMETER | CONDITIONS | MIN | TYP | MAX | UNIT |
|---|--|-------|---------|-------|------------------|
| SUPPLY VOLTAGE (VIN PIN) | | | | | |
| Operating input voltage | V_{IN} | 4.7 | | 60 | V |
| Shutdown supply current | $EN = 0V$ | | 1.7 | | μA |
| I_q Operating – Non switching | $V_{SENSE} = 0.9V$, $V_{IN} = 12V$ | | 89 | 110 | μA |
| ENABLE AND UVLO (EN PIN) | | | | | |
| Enable threshold | Rising | | 1.24 | 1.4 | V |
| | Falling | 1 | 1.14 | | V |
| Input current | Enable threshold +50 mV | | -4.7 | | μA |
| | Enable threshold -50 mV | | -1.2 | | μA |
| Hysteresis | | | 3.5 | | μA |
| Enable to start switching time | | | 450 | | μs |
| VIN | | | | | |
| VIN start voltage | VIN rising | | 4.53 | | V |
| VOLTAGE REFERENCE | | | | | |
| Voltage reference | $1\text{mA} < I_{OUT} < \text{Minimum Current Limit}$ | 0.784 | 0.8 | 0.816 | V |
| HIGH-SIDE MOSFET | | | | | |
| Switch resistance | $BOOT-PH = 5.7V$ | | 1.5 | 2.8 | Ω |
| LOW-SIDE MOSFET | | | | | |
| Switch resistance | $V_{IN} = 12V$ | | 0.8 | 1.5 | Ω |
| ERROR AMPLIFIER | | | | | |
| Input Current | V_{SENSE} pin | | 20 | | nA |
| Error amp gm | $-2\mu\text{A} < I_{(COMP)} < 2\mu\text{A}$, $V_{(COMP)} = 1V$ | | 102 | | μMhos |
| EA gm during slow start | $-2\mu\text{A} < I_{(COMP)} < 2\mu\text{A}$, $V_{(COMP)} = 1V$, $V_{SENSE} = 0.4V$ | | 26 | | μMhos |
| Error amp dc gain | $V_{SENSE} = 0.8V$ | | 1000 | | V/V |
| Min unity gain bandwidth | | | 0.5 | | MHz |
| Error amp source/sink | $V_{(COMP)} = 1V$, 100 mV Overdrive | | ± 8 | | μA |
| Start Switching Threshold | | | 0.57 | | V |
| COMP to I_{switch} gm | | | 0.65 | | A/V |
| CURRENT LIMIT | | | | | |
| High side sourcing current limit threshold | $V_{IN} = 12V$ $BOOT-PH = 5.7V$ | 75 | 134 | | mA |
| Zero cross detect current | | | -0.7 | | mA |
| THERMAL SHUTDOWN | | | | | |
| Thermal shutdown | | | 146 | | C |
| RT/CLK | | | | | |
| Operating frequency using RT mode | | 100 | | 400 | kHz |
| Switching frequency | $R_{(RT/CLK)} = 510\text{k}\Omega$ | 192 | 240 | 288 | kHz |
| Minimum CLK pulsewidth | | | 40 | | ns |
| RT/CLK voltage | $R_{(RT/CLK)} = 510\text{k}\Omega$ | | 0.53 | | V |
| RT/CLK high threshold | | | | 1.3 | V |
| RT/CLK low threshold | | 0.5 | | | V |
| RT/CLK falling edge to PH rising edge delay | Measure at 240 kHz with RT resistor in series | | 100 | 200 | ns |
| PLL lock in time | Measure at 240 kHz | | 100 | | μA |
| PLL frequency range | | 300 | | 400 | kHz |

(1) The Electrical Ratings specified in this section will apply to all specifications in this document unless otherwise noted. These specifications will be interpreted as conditions that will not degrade the device's parametric or functional specifications for the life of the product containing it.

ELECTRICAL CHARACTERISTICS⁽¹⁾ (continued)TEST CONDITIONS: $T_J = -40^{\circ}\text{C}$ to 125°C , $V_{IN} = 4.7$ To 60 V ((unless otherwise noted)

| PARAMETER | CONDITIONS | MIN | TYP | MAX | UNIT |
|---------------------------------|---|-----|-----|-----|------|
| PH | | | | | |
| Minimum On time | Measured at 50% to 50% of V_{IN} $I_{OUT} = 50\text{mA}$ | | 120 | | ns |
| Dead time | $V_{IN} = 12\text{V}$, $I_{OUT} = 50\text{mA}$, One transition | | 30 | | ns |
| BOOT | | | | | |
| BOOT to PH regulation voltage | $V_{IN} = 12\text{V}$ | | 5.7 | | V |
| BOOT-PH UVLO | | | 2.9 | | V |
| INTERNAL SLOW START TIME | | | | | |
| Slow start time | $f_{SW} = 240\text{kHz}$, $R_T = 510\text{k}\Omega$, 10% to 90% | | 4.1 | | ms |

TYPICAL CHARACTERISTICS

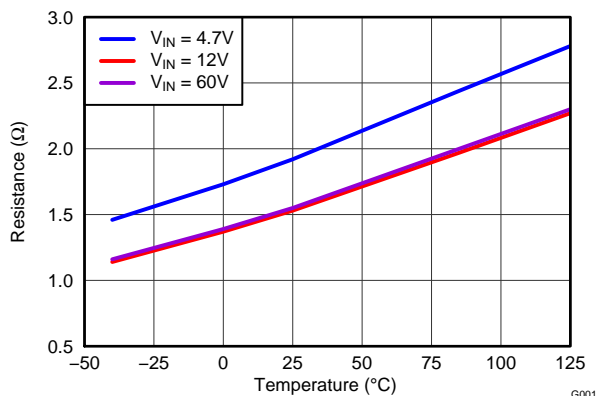

Figure 1. High Side $R_{DS(on)}$ vs Temperature

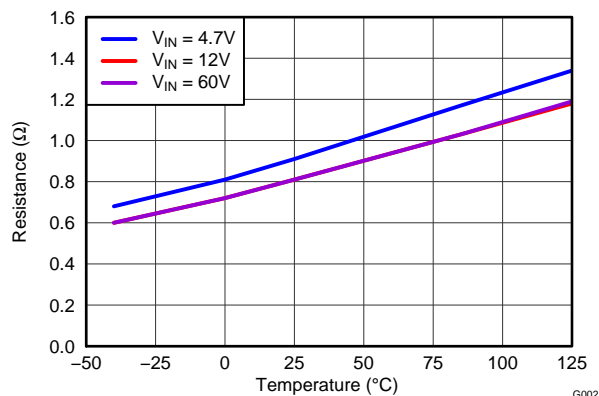

Figure 2. Low Side $R_{DS(on)}$ vs Temperature

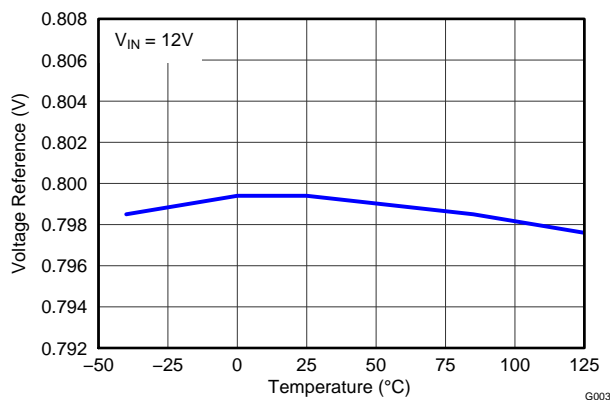

Figure 3. V_{REF} Voltage vs Temperature

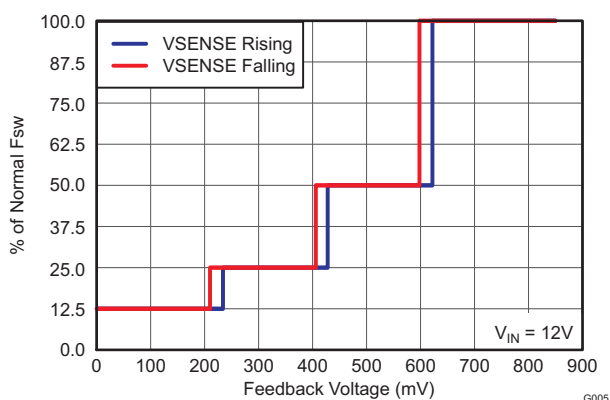

Figure 4. Frequency vs V_{SENSE} Voltage

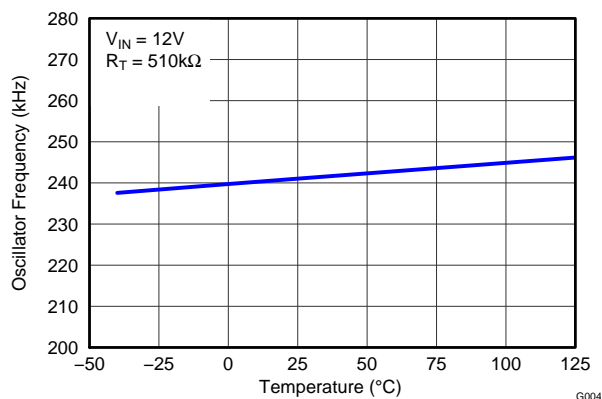

Figure 5. Frequency vs Temperature

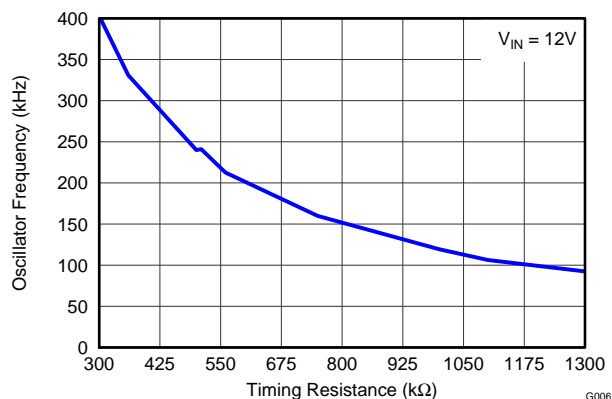

Figure 6. Frequency vs R_T/CLK Resistance

TYPICAL CHARACTERISTICS (continued)

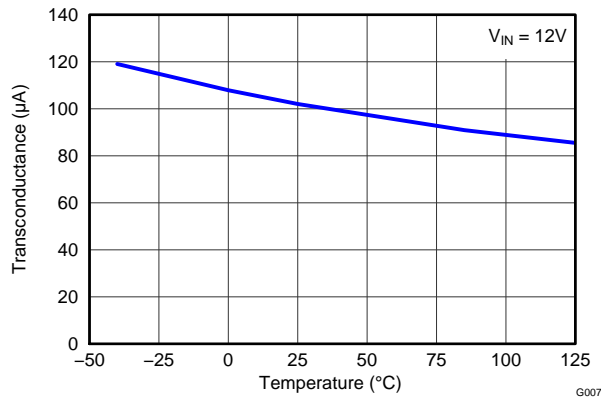

Figure 7. Error Amp Transconductance vs Temperature

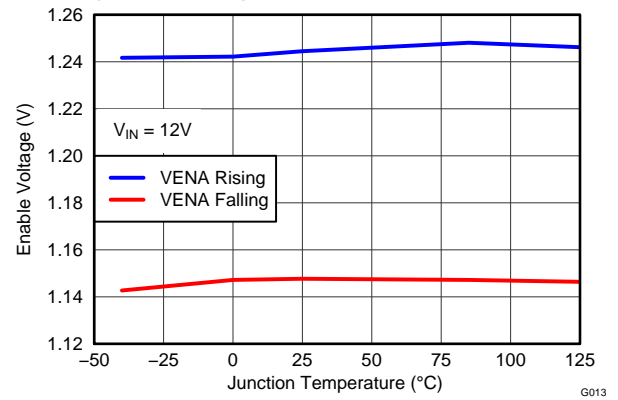

Figure 8. Enable Pin Voltage vs Temperature

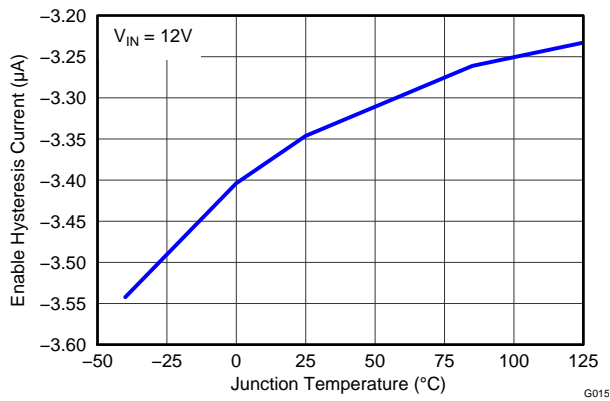

Figure 9. Enable Pin Hysteresis Current vs Temperature

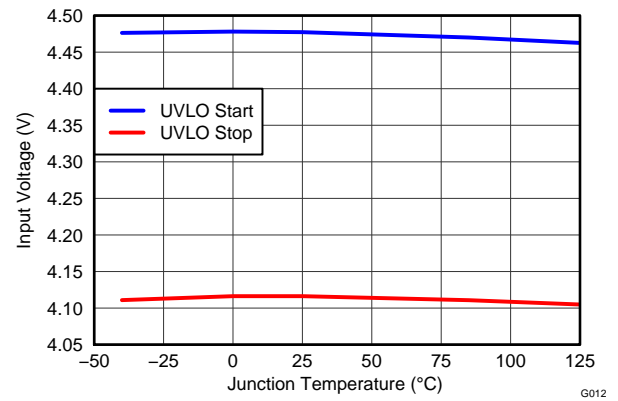

Figure 10. Input Voltage (UVLO) vs Temperature

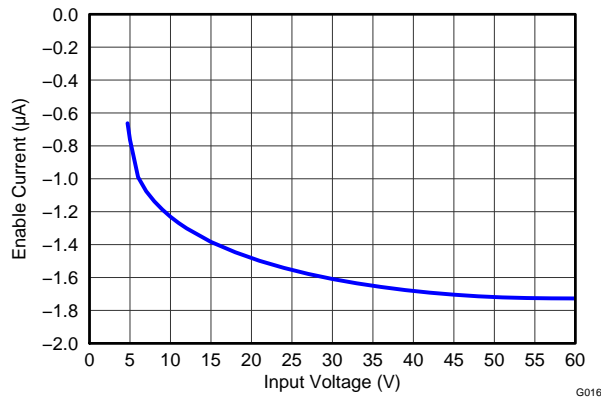

Figure 11. Enable Pin Pull Up Current vs Input Voltage

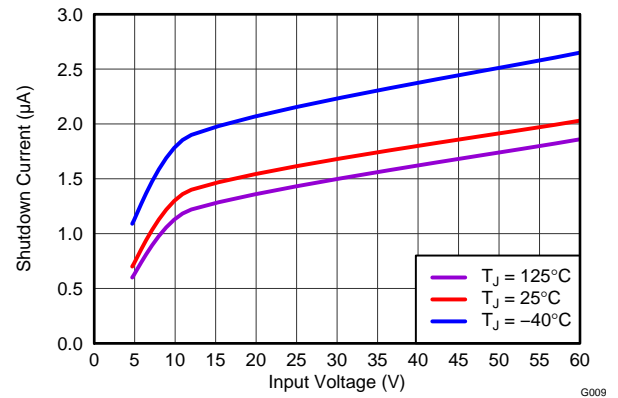

Figure 12. Shutdown Supply Current (VIN) vs Input Voltage

TYPICAL CHARACTERISTICS (continued)

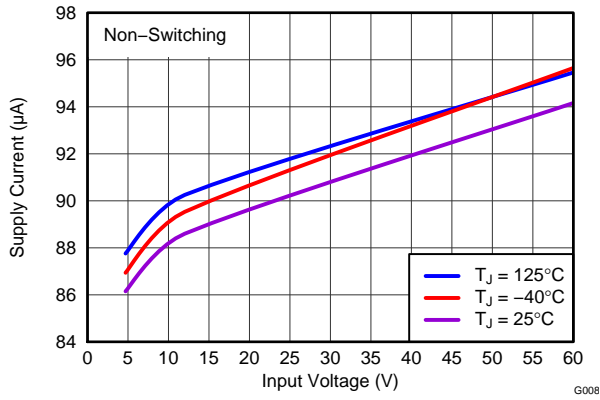

Figure 13. Supply Current (VIN pin) vs Input Voltage

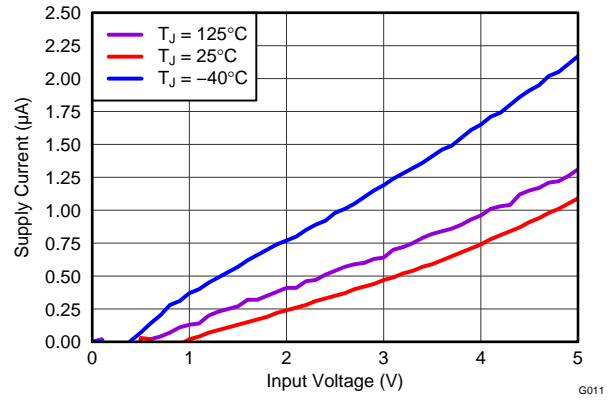

Figure 14. Supply Current (VIN pin) vs Input Voltage (0V to VSTART) EN Pin Low

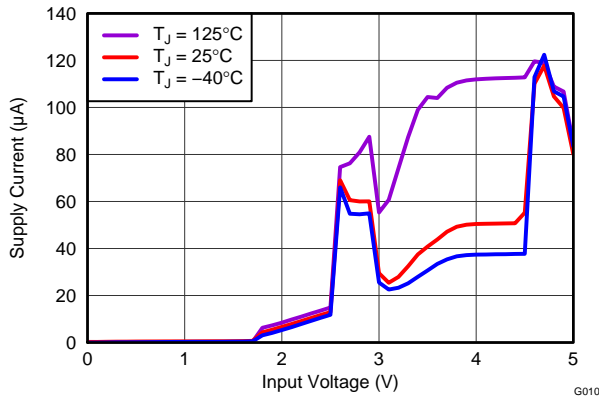

Figure 15. Supply Current (VIN pin) vs Input Voltage (0V to V_{START}) EN Pin Open

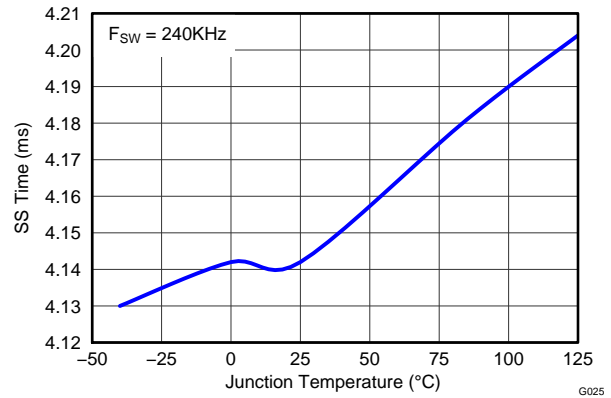

Figure 16. Slow Start Time vs Temperature

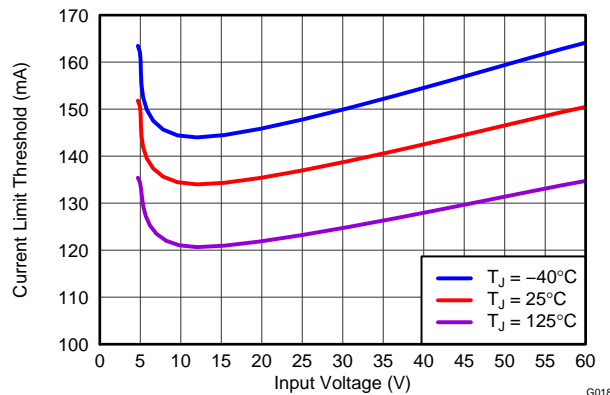

Figure 17. Current Limit vs Input Voltage

OVERVIEW

The TPS54062 device is a 60V, 50mA, step-down (buck) regulator with an integrated high side and low side n-channel MOSFET. To improve performance during line and load transients the device implements a constant frequency, current mode control which reduces output capacitance and simplifies external frequency compensation design.

The switching frequency of 100 kHz to 400 kHz allows for efficiency and size optimization when selecting the output filter components. The switching frequency is adjusted using a resistor to ground on the RT/CLK pin. The device has an internal phase lock loop (PLL) on the RT/CLK pin that is used to synchronize the power switch turn on to a falling edge of an external system clock.

The TPS54062 has a default start up voltage of approximately 4.5V. The EN pin has an internal pull-up current source that can be used to adjust the input voltage undervoltage lockout (UVLO) threshold with two external resistors. In addition, the pull up current provides a default condition. When the EN pin is floating the device will operate. The operating current is 89uA when not switching and under no load. When the device is disabled, the supply current is 1.7μA.

The integrated 1.5Ω high side MOSFET and 0.8Ω low side MOSFET allows for high efficiency power supply designs capable of delivering 50 milliamperes of continuous current to a load.

The TPS54062 reduces the external component count by integrating the boot recharge diode. The bias voltage for the integrated high side MOSFET is supplied by a capacitor on the BOOT to PH pin. The boot capacitor voltage is monitored by an UVLO circuit and will turn the high side MOSFET off when the boot voltage falls below a preset threshold. The TPS54062 can operate at high duty cycles because of the boot UVLO. The output voltage can be stepped down to as low as the 0.8V reference.

The TPS54062 has an internal output OV protection that disables the high side MOSFET if the output voltage is 109% of the nominal output voltage.

The TPS54062 reduces external component count by integrating the slow start time using a reference DAC system.

The TPS54062 resets the slow start times during overload conditions with an overload recovery circuit. The overload recovery circuit will slow start the output from the fault voltage to the nominal regulation voltage once a fault condition is removed. A frequency foldback circuit reduces the switching frequency during startup and overcurrent fault conditions to help control the inductor current.

DETAILED DESCRIPTION

Fixed Frequency PWM Control

The TPS54062 uses an adjustable fixed frequency, peak current mode control. The output voltage is compared through external resistors on the VSENSE pin to an internal voltage reference by an error amplifier which drives the COMP pin. An internal oscillator initiates the turn on of the high side power switch. The error amplifier output is compared to the high side power switch current. When the power switch current reaches the level set by the COMP voltage, the power switch is turned off. The COMP pin voltage will increase and decrease as the output current increases and decreases. The device implements a current limit by clamping the COMP pin voltage to a maximum level.

Slope Compensation Output Current

The TPS54062 adds a compensating ramp to the switch current signal. This slope compensation prevents sub-harmonic oscillations.

Error Amplifier

The TPS54062 has a transconductance amplifier for the error amplifier. The error amplifier compares the VSENSE voltage to the lower of the internal slow start voltage or the internal 0.8V voltage reference. The transconductance (gm) of the error amplifier is 102µA/V during normal operation. During the slow start operation, the transconductance is a fraction of the normal operating gm. The frequency compensation components (capacitor, series resistor and capacitor) are added to the COMP pin to ground.

Voltage Reference

The voltage reference system produces a precise ±2 voltage reference over temperature by scaling the output of a temperature stable band-gap circuit

Adjusting the Output Voltage

The output voltage is set with a resistor divider from the output node to the VSENSE pin. It is recommended to use 1% tolerance or better divider resistors. Start with a 10kΩ for the R_{LS} resistor and use the [Equation 1](#) to calculate R_{HS}.

$$R_{HS} = R_{LS} \times \left(\frac{V_{OUT} - 0.8 \text{ V}}{0.8 \text{ V}} \right) \quad (1)$$

Enable and Adjusting Undervoltage Lockout

The TPS54062 is enabled when the VIN pin voltage rises above 4.53V. If an application requires a higher undervoltage lockout (UVLO), use the EN pin as shown in [Figure 18](#) to adjust the input voltage UVLO by using the two external resistors. Though it is not necessary to use the UVLO adjust registers, for operation it is highly recommended to provide consistent power up behavior. The EN pin has an internal pull-up current source, I₁, of 1.2µA that provides the default condition of the TPS54062 operating when the EN pin floats. Once the EN pin voltage exceeds 1.24V, an additional 3.5µA of hysteresis, I_{hys}, is added. This additional current facilitates input voltage hysteresis. When the EN pin is pulled below 1.14V, the 3.5µA is removed. Use [Equation 2](#) to set the external hysteresis for the input voltage. Use [Equation 3](#) to set the input stop voltage.

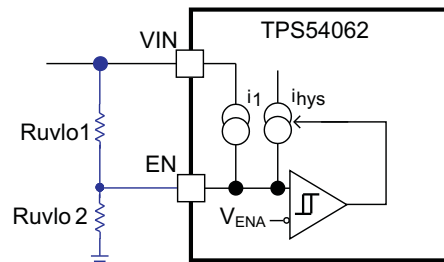

Figure 18. Adjustable Undervoltage Lock Out

$$R_{UVLO1} = \frac{V_{START} \left(\frac{V_{ENAFALLING}}{V_{ENARISING}} \right) - V_{STOP}}{I_1 \times \left(1 - \frac{V_{ENAFALLING}}{V_{ENARISING}} \right) + I_{HYS}} \quad (2)$$

$$R_{UVLO2} = \frac{R_{UVLO1} \times V_{ENAFALLING}}{V_{STOP} - V_{ENAFALLING} + R_{UVLO1} \times (I_1 + I_{HYS})} \quad (3)$$

Do not place a low-impedance voltage source with greater than 5V directly on the EN pin. Do not place a capacitor directly on the EN pin if $V_{EN} > 5V$ when using a voltage divider to adjust the start and stop voltage. The node voltage, (see [Figure 19](#)) must remain equal to or less than 5.8V. The zener diode can sink up to 100 μ A. The EN pin voltage can be greater than 5V if the VIN voltage source has a high impedance and does not source more than 100 μ A into the EN pin.

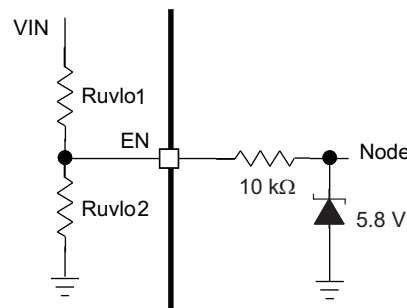

Figure 19. Node Voltage

Constant Switching Frequency and Timing Resistor (RT/CLK Pin)

The switching frequency of the TPS54062 is adjustable over a wide range from approximately 100kHz to 400 kHz by placing a resistor on the RT/CLK pin. The RT/CLK pin voltage is typically 0.53V and must have a resistor to ground to set the switching frequency. To determine the timing resistance for a given switching frequency, use [Equation 4](#). To reduce the solution size one would typically set the switching frequency as high as possible, but tradeoffs of the supply efficiency, maximum input voltage and minimum controllable on time should be considered. The minimum controllable on time is typically 130ns and limits the maximum operating input voltage. The maximum switching frequency is also limited by the frequency shift circuit. More discussion on the details of the maximum switching frequency is located below.

$$R_T(k\Omega) = \frac{116720}{f_{SW}(kHz)^{0.9967}} \quad (4)$$

Selecting the Switching Frequency

The TPS54062 implements current mode control which uses the COMP pin voltage to turn off the high side MOSFET on a cycle-by-cycle basis. Each cycle the switch current and COMP pin voltage are compared, when the peak switch current intersects the COMP voltage, the high side switch is turned off. During overcurrent conditions that pull the output voltage low, the error amplifier will respond by driving the COMP pin high, increasing the switch current. The error amplifier output is clamped internally, which functions as a switch current limit.

To increase the maximum operating switching frequency at high input voltages the TPS54062 implements a frequency shift. The switching frequency is divided by 8, 4, 2, and 1 as the voltage ramps from 0 to 0.8 volts on VSENSE pin. The device implements a digital frequency shift to enable synchronizing to an external clock during normal startup and fault conditions. Since the device can only divide the switching frequency by 8, there is a maximum input voltage limit in which the device operates and still have frequency shift protection. During

short-circuit events (particularly with high input voltage applications), the control loop has a finite minimum controllable on time and the output has a low voltage. During the switch on time, the inductor current ramps to the peak current limit because of the high input voltage and minimum on time. During the switch off time, the inductor would normally not have enough off time and output voltage for the inductor to ramp down by the ramp up amount. The frequency shift effectively increases the off time allowing the current to ramp down.

$$f_{SW}(\text{maxskip}) = \left(\frac{1}{t_{ON}} \right) \times \left(\frac{V_{OUT} + R_{LS} \times I_O + R_{DC} \times I_O}{V_{IN} - I_O \times R_{HS} + I_O \times R_{LS}} \right) \quad (5)$$

$$f_{SW}(\text{shift}) = \left(\frac{f_{div}}{t_{ON}} \right) \times \left(\frac{V_{OUTSC} + R_{LS} \times I_{CL} + R_{DC} \times I_{CL}}{V_{IN} - I_{CL} \times R_{HS} + I_{CL} \times R_{LS}} \right) \quad (6)$$

Where:

- I_O = Output current
- I_{CL} = Current Limit
- V_{IN} = Input Voltage
- V_{OUT} = Output Voltage
- V_{OUTSC} Output Voltage during short
- R_{DC} = Inductor resistance
- R_{HS} = High side MOSFET resistance
- R_{LS} = Low side MOSFET resistance
- t_{on} = Controllable on time
- fdiv = Frequency divide (equals 1, 2, 4, or 8)

How to Interface to RT/CLK Pin

The RT/CLK pin can be used to synchronize the regulator to an external system clock. To implement the synchronization feature connect a square wave to the RT/CLK pin through one of the circuit networks shown in Figure 20. The square wave amplitude must transition lower than 0.5V and higher than 1.3V on the RT/CLK pin and have an on time greater than 40 ns and an off time greater than 40ns. The synchronization frequency range is 300kHz to 400kHz. The rising edge of the PH will be synchronized to the falling edge of RT/CLK pin signal. The external synchronization circuit should be designed in such a way that the device will have the default frequency set resistor connected from the RT/CLK pin to ground should the synchronization signal turn off. It is recommended to use a frequency set resistor connected as shown in Figure 20 through another resistor (e.g., 50Ω) to ground for clock signal that are not Hi-Z or 3-state during the off state. The sum of the resistance should set the switching frequency close to the external CLK frequency. It is recommended to ac couple the synchronization signal through a 10pF ceramic capacitor to RT/CLK pin. The first time the CLK is pulled above the CLK threshold the device switches from the RT resistor frequency to PLL mode. The internal 0.5V voltage source is removed and the CLK pin becomes high impedance as the PLL starts to lock onto the external signal. Since there is a PLL on the regulator the switching frequency can be higher or lower than the frequency set with the external resistor. The device transitions from the resistor mode to the PLL mode and then will increase or decrease the switching frequency until the PLL locks onto the CLK frequency within 100 microseconds. When the device transitions from the PLL to resistor mode the switching frequency will slow down from the CLK frequency to 150kHz, then reapply the 0.5V voltage and the resistor will then set the switching frequency. The switching frequency is divided by 8, 4, 2, and 1 as the voltage ramps from 0 to 0.8 volts on VSENSE pin. The device implements a digital frequency shift to enable synchronizing to an external clock during normal startup and fault conditions.

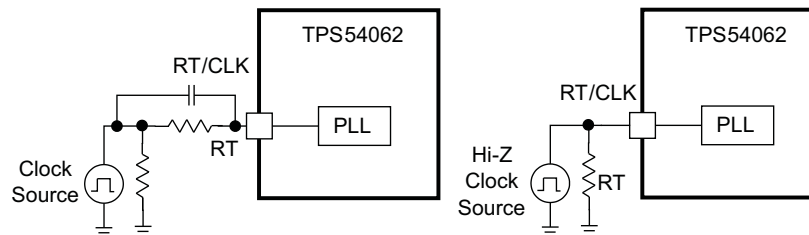

Figure 20. Synchronizing to a System Clock

Overvoltage Transient Protection

The TPS54062 incorporates an overvoltage transient protection (OVTP) circuit to minimize voltage overshoot when recovering from output fault conditions or strong unload transients on power supply designs with low value output capacitance. For example, when the power supply output is overloaded the error amplifier compares the actual output voltage to the internal reference voltage. If the VSENSE pin voltage is lower than the internal reference voltage for a considerable time, the output of the error amplifier will respond by clamping the error amplifier output to a high voltage. Thus, requesting the maximum output current. Once the condition is removed, the regulator output rises and the error amplifier output transitions to the steady state duty cycle. In some applications, the power supply output voltage can respond faster than the error amplifier output can respond, this actuality leads to the possibility of an output overshoot.

The OVTP feature minimizes the output overshoot, when using a low value output capacitor, by implementing a circuit to compare the VSENSE pin voltage to OVTP threshold which is 109% of the internal voltage reference. If the VSENSE pin voltage is greater than the OVTP threshold, the high side MOSFET is disabled preventing current from flowing to the output and minimizing output overshoot. When the VSENSE voltage drops lower than the OVTP threshold, the high side MOSFET is allowed to turn on at the next clock cycle.

Thermal Shutdown

The device implements an internal thermal shutdown to protect itself if the junction temperature exceeds 146°C. The thermal shutdown forces the device to stop switching when the junction temperature exceeds the thermal trip threshold. Once the die temperature decreases below 146°C, the device reinitiates the power up sequence by restarting the internal slow start.

DESIGN GUIDE – STEP-BY-STEP DESIGN PROCEDURE No.1

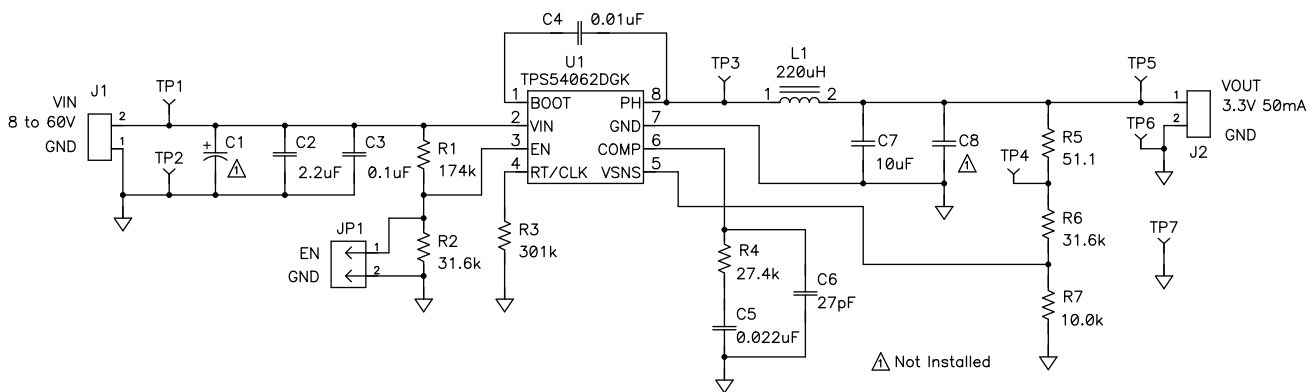

Figure 21. Application Schematic

This example details the design of a continuous conduction mode (CCM) switching regulator design using ceramic output capacitors. If a low output current design is needed go to the design procedure Number 2. A few parameters must be known in order to start the design process. These parameters are typically determined at the system level. For this example, we will start with the following known parameters:

| | |
|--|------------------------|
| Output Voltage | 3.3V |
| Transient Response 0 to 50mA load step | $\Delta V_{OUT} = 4\%$ |
| Maximum Output Current | 50mA |
| Input Voltage | 24 V nom. 8V to 60V |
| Output Voltage Ripple | 0.5% of V_{OUT} |
| Start Input Voltage (rising VIN) | 7.88V |
| Stop Input Voltage (falling VIN) | 6.66V |

Selecting the Switching Frequency

The first step is to decide on a switching frequency for the regulator. Typically, the user will want to choose the highest switching frequency possible since this will produce the smallest solution size. The high switching frequency allows for lower valued inductors and smaller output capacitors compared to a power supply that switches at a lower frequency. The switching frequency that can be selected is limited by the minimum on-time of the internal power switch, the input voltage and the output voltage and the frequency shift limitation.

[Equation 5](#) and [Equation 6](#) must be used to find the maximum switching frequency for the regulator, choose the lower value of the two equations. Switching frequencies higher than these values will result in pulse skipping or the lack of overcurrent protection during a short circuit. The typical minimum on time, $t_{on,min}$, is 130ns for the TPS54062. For this example, the output voltage is 3.3V and the maximum input voltage is 60 V, which allows for a maximum switch frequency up to 400 kHz when including the inductor resistance, on resistance and diode voltage in [Equation 5](#) or [Equation 6](#). To ensure overcurrent runaway is not a concern during short circuits in your design use [Equation 6](#) to determine the maximum switching frequency. With a maximum input voltage of 60V, inductor resistance of 3.7Ω , high side switch resistance of 2.3Ω , low side switch resistance of 1.1Ω , a current limit value of 120 mA and a short circuit output voltage of 0.1V.

The maximum switching frequency is 400 kHz in both cases and a switching frequency of 400 kHz is used. To determine the timing resistance for a given switching frequency, use [Equation 4](#). The switching frequency is set by resistor R3 shown in [Figure 21](#). R3 is calculated to be 298 k Ω . A standard value of 301 k Ω is used.

Output Inductor Selection (LO)

To calculate the minimum value of the output inductor, use [Equation 7](#). KIND is a coefficient that represents the amount of inductor ripple current relative to the maximum output current. The inductor ripple current will be filtered by the output capacitor. Therefore, choosing high inductor ripple currents will impact the selection of the output capacitor since the output capacitor must have a ripple current rating equal to or greater than the inductor ripple current. In general, the inductor ripple value is at the discretion of the designer; however, the following guidelines may be used. Typically it is recommended to use KIND values in the range of 0.2 to 0.4; however, for designs using low ESR output capacitors such as ceramics and low output currents, a value as high as $KIND = 1$ may be used. In a wide input voltage regulator, it is best to choose an inductor ripple current on the larger side. This allows the inductor to still have a measurable ripple current with the input voltage at its minimum. For this design example, use $KIND = 0.8$ and the minimum inductor value is calculated to be 195 μ H. For this design, a near standard value was chosen: 220 μ H. For the output filter inductor, it is important that the RMS current and saturation current ratings not be exceeded. The RMS and peak inductor current can be found from [Equation 9](#) and [Equation 10](#).

For this design, the RMS inductor current is 50 mA and the peak inductor current is 68 mA. The chosen inductor is a Coilcraft LPS4018-224ML. It has a saturation current rating of 235 mA and an RMS current rating of 200 mA. As the equation set demonstrates, lower ripple currents will reduce the output voltage ripple of the regulator but will require a larger value of inductance. Selecting higher ripple currents will increase the output voltage ripple of the regulator but allow for a lower inductance value. The current flowing through the inductor is the inductor ripple current plus the output current. During power up, faults or transient load conditions, the inductor current can increase above the calculated peak inductor current level calculated above. In transient conditions, the inductor current can increase up to the switch current limit of the device. For this reason, the most conservative approach is to specify an inductor with a saturation current rating equal to or greater than the switch current limit rather than the peak inductor current.

$$L_{Omin} \geq \left(\frac{V_{Smax} - V_{OUT}}{KIND \times I_O} \right) \times \frac{V_{OUT}}{V_{Smax} \times f_{SW}} \quad (7)$$

$$I_{RIPPLE} \geq \frac{V_{OUT} \times (V_{INmax} - V_{OUT})}{V_{INmax} \times L_O \times f_{SW}} \quad (8)$$

$$I_{Lrms} = \sqrt{I_O^2 + \frac{1}{12} \times \left(\frac{V_{OUT} \times (V_{INmax} - V_{OUT})}{V_{INmax} \times L_O \times f_{SW}} \right)^2} \quad (9)$$

$$I_{Lpeak} = I_{OUT} + \frac{I_{RIPPLE}}{2} \quad (10)$$

Output Capacitor

There are three primary considerations for selecting the value of the output capacitor. The output capacitor will determine the modulator pole, the output voltage ripple, and how the regulator responds to a large change in load current. The output capacitance needs to be selected based on the more stringent of these three criteria. The desired response to a large change in the load current is the first criteria. The output capacitor needs to supply the load with current when the regulator can not. This situation would occur if there are desired hold-up times for the regulator where the output capacitor must hold the output voltage above a certain level for a specified amount of time after the input power is removed. The regulator also will temporarily not be able to supply sufficient output current if there is a large, fast increase in the current needs of the load such as transitioning from no load to a full load. The regulator usually needs two or more clock cycles for the control loop to see the change in load current and output voltage and adjust the duty cycle to react to the change. The output capacitor must be sized to supply the extra current to the load until the control loop responds to the load change. The output capacitance must be large enough to supply the difference in current for 2 clock cycles while only allowing a tolerable amount of droop in the output voltage. Equation 14 shows the minimum output capacitance necessary to accomplish this. Where ΔI_{out} is the change in output current, f_{sw} is the regulators switching frequency and ΔV_{out} is the allowable change in the output voltage.

For this example, the transient load response is specified as a 4% change in V_{out} for a load step from 0A (no load) to 50 mA (full load). For this example, $\Delta I_{OUT} = 0.05 - 0 = 0.05$ and $\Delta V_{OUT} = 0.04 \times 3.3 = 0.132$.

Using these numbers gives a minimum capacitance of 1.89 μF . This value does not take the ESR of the output capacitor into account in the output voltage change. For ceramic capacitors, the ESR is usually small enough to ignore in this calculation. Aluminum electrolytic and tantalum capacitors have higher ESR that should be taken into account. The low side FET of the regulator emulates a diode so it can not sink current so any stored energy in the inductor will produce an output voltage overshoot when the load current rapidly decreases, see Figure 27. The output capacitor must also be sized to absorb energy stored in the inductor when transitioning from a high load current to a lower load current. The excess energy that gets stored in the output capacitor will increase the voltage on the capacitor. The capacitor must be sized to maintain the desired output voltage during these transient periods. Equation 13 is used to calculate the minimum capacitance to keep the output voltage overshoot to a desired value. Where L is the value of the inductor, I_{OH} is the output current under heavy load, I_{OL} is the output under light load, V_F is the final peak output voltage, and V_i is the initial capacitor voltage. For this example, the worst case load step will be from 50 mA to 0A. The output voltage will increase during this load transition and the stated maximum in our specification is 4% of the output voltage. This will make $V_F = 1.04 \times 3.3 = 3.432$ V. V_i is the initial capacitor voltage which is the nominal output voltage of 3.3 V. Using these numbers in Equation 14 yields a minimum capacitance of 0.619 μF .

Equation 12 calculates the minimum output capacitance needed to meet the output voltage ripple specification. Where f_{sw} is the switching frequency, V_{ripple} is the maximum allowable output voltage ripple, and I_{ripple} is the inductor ripple current. Equation 13 yields 0.671 μF . Equation 15 calculates the maximum ESR an output capacitor can have to meet the output voltage ripple specification. Equation 16 indicates the ESR should be less than 0.466 Ω .

The most stringent criteria for the output capacitor is 1.89 μF of capacitance to keep the output voltage in regulation during an load transient.

Additional capacitance de-ratings for aging, temperature and dc bias should be factored in which will increase this minimum value. For this example, 10 μF , 10V X5R ceramic capacitor with 0.003 Ω of ESR will be used. Capacitors generally have limits to the amount of ripple current they can handle without failing or producing excess heat. An output capacitor that can support the inductor ripple current must be specified. Some capacitor data sheets specify the Root Mean Square (RMS) value of the maximum ripple current.

Equation 11 can be used to calculate the RMS ripple current the output capacitor needs to support. For this application, Equation 11 yields 10.23 mA.

$$I_{C_{O,rms}} = \frac{1}{\sqrt{12}} \times \left(\frac{V_{OUT} \times (V_{IN,max} - V_{OUT})}{V_{IN,max} \times L_O \times f_{SW}} \right) \quad (11)$$

$$C_{O1} \geq \frac{I_{RIPPLE}}{V_{RIPPLE}} \times \left(\frac{1}{8 \times f_{SW}} \right) \quad (12)$$

$$C_{O2} \geq L_O \times \frac{(I_O^2 - 0^2)}{(V_O + \Delta V) - V_O^2} \quad (13)$$

$$C_{O3} \geq L_O \times \frac{I_O}{\Delta V} \times \frac{2}{f_{SW}} \quad (14)$$

$$R_C \leq \frac{V_{RIPPLE}}{I_{RIPPLE}} \quad (15)$$

Input capacitor

The TPS54062 requires a high quality ceramic, type X5R or X7R, input decoupling capacitor of at least 1µF of effective capacitance and in some applications a bulk capacitance. The effective capacitance includes any dc bias effects. The voltage rating of the input capacitor must be greater than the maximum input voltage. The capacitor must also have a rms current rating greater than the maximum rms input current of the TPS54062. The input rms current can be calculated using Equation 16. The value of a ceramic capacitor varies significantly over temperature and the amount of dc bias applied to the capacitor. The capacitance variations due to temperature can be minimized by selecting a dielectric material that is stable over temperature. X5R and X7R ceramic dielectrics are usually selected for power regulator capacitors because they have a high capacitance to volume ratio and are fairly stable over temperature. The output capacitor must also be selected with the dc bias taken into account. The capacitance value of a capacitor decreases as the dc bias across a capacitor increases. For this example design, a ceramic capacitor with at least a 100 V voltage rating is required to support the maximum input voltage. The input capacitance value determines the input ripple voltage of the regulator. The input voltage ripple can be calculated using rearranging Equation 17.

Using the design example values, $I_{OUTmax} = 50$ mA, $C_{IN} = 2.2$ µF, $f_{SW} = 400$ kHz, yields an input voltage ripple of 14.2 mV and a rms input ripple current of 24.6 mA.

$$I_{C_{IN}rms} = I_{OUT} \times \sqrt{\frac{V_{OUT}}{V_{INmin}} \times \frac{(V_{INmin} - V_{OUT})}{V_{INMin}}} \quad (16)$$

$$C_{IN} \geq \frac{I_O}{V_{INripple}} \times \left(\frac{0.25}{f_{SW}} \right) \quad (17)$$

Bootstrap Capacitor Selection

A 0.01-µF ceramic capacitor must be connected between the BOOT and PH pins for proper operation. It is recommended to use a ceramic capacitor with X5R or better grade dielectric. The capacitor should have a 10V or higher voltage rating.

Under Voltage Lock Out Set Point

The Under Voltage Lock Out (UVLO) can be adjusted using an external voltage divider on the EN pin of the TPS54062. The UVLO has two thresholds, one for power up when the input voltage is rising and one for power down or brown outs when the input voltage is falling. For the example design, the supply should turn on and start switching once the input voltage increases above 7.88 V (enabled). After the regulator starts switching, it should continue to do so until the input voltage falls below 6.66 V (UVLO stop). The programmable UVLO and enable voltages are set using a resistor divider between V_{in} and ground to the EN pin. Equation 2 through Equation 3 can be used to calculate the resistance values necessary. For the example application, a 174 kΩ resistor between V_{in} and EN and a 31.6 kΩ resistor between EN and ground are required to produce the 7.88 and 6.66 volt start and stop voltages.

Output Voltage and Feedback Resistors Selection

For the example design, 10 kΩ was selected for R_{LS} . Using Equation 1, R_{HS} is calculated as 31.25 kΩ. The nearest standard 1% resistor is 31.6 kΩ.

Closing the Loop

There are several methods used to compensate DC/DC regulators. The method presented here is easy to calculate and ignores the effects of the slope compensation that is internal to the device. Since the slope compensation is ignored, the actual cross over frequency will usually be lower than the cross over frequency used in the calculations. This method assume the crossover frequency is between the modulator pole and the ESR zero and the ESR zero is at least 10 times greater the modulator pole. Use SwitcherPro™ software for a more accurate design.

To get started, the modulator pole, fpole, and the ESR zero, fzero must be calculated using [Equation 18](#) and [Equation 19](#). For Cout, use a derated value of 8.9 μF. Use [Equation 21](#) and [Equation 22](#), to estimate a starting point for the crossover frequency, fco, to design the compensation. For the example design, fpole is 271 Hz and fzero is 5960 kHz.

[Equation 21](#) is the geometric mean of the modulator pole and the esr zero and [Equation 22](#) is the mean of modulator pole and the switching frequency. [Equation 21](#) yields 40.29 kHz and [Equation 22](#) gives 7.36 kHz. Use a frequency near the lower value of [Equation 21](#) or [Equation 22](#) for an initial crossover frequency.

For this example, fco is 7.8 kHz. Next, the compensation components are calculated. A resistor in series with a capacitor is used to create a compensating zero. A capacitor in parallel to these two components forms the compensating pole.

To determine the compensation resistor, R4, use [Equation 22](#). Assume the power stage transconductance, gm_{ps}, is 0.65 A/V. The output voltage, Vo, reference voltage, V_{REF}, and amplifier transconductance, g_{mea}, are 3.3 V, 0.8 V and 102 μA/V, respectively.

R4 is calculated to be 27.1 kΩ, use the nearest standard value of 27.4 kΩ. Use [Equation 23](#) to set the compensation zero to the modulator pole frequency. [Equation 23](#) yields 0.021.4 μF for compensating capacitor C5, a 0.022 μF is used on the board. Use the larger value of [Equation 24](#) and [Equation 25](#) to calculate the C6 value, to set the compensation pole. [Equation 25](#) yields 29 pF so the nearest standard of 27 pF is used.

$$f_{\text{pole}}(\text{Hz}) = \frac{1}{\frac{V_o}{I_o} \times C_o \times 2 \times \pi} \quad (18)$$

$$f_{\text{zero}}(\text{Hz}) = \frac{1}{R_c \times C_o \times 2 \times \pi} \quad (19)$$

$$f_{\text{co1}}(\text{Hz}) = (f_{\text{zero}} \times f_{\text{pole}})^{0.5} \quad (20)$$

$$f_{\text{co2}}(\text{Hz}) = \left(\frac{f_{\text{sw}}}{2} \times f_{\text{pole}} \right)^{0.5} \quad (21)$$

$$R_{\text{COMP}} = \frac{2 \times \pi \times f_{\text{CO}}}{g_{\text{mps}}} \times \frac{V_o}{V_{\text{REF}} \times g_{\text{mea}}} \quad (22)$$

$$C_{\text{COMP}} = \frac{1}{2 \times \pi \times R_{\text{COMP}} \times f_{\text{POLE}}} \quad (23)$$

$$C_{\text{POLE1}} = \frac{R_c \times C_o}{R_{\text{COMP}}} \quad (24)$$

$$C_{\text{POLE2}} = \frac{1}{R_{\text{COMP}} \times f_{\text{SW}} \times \pi} \quad (25)$$

Characteristics

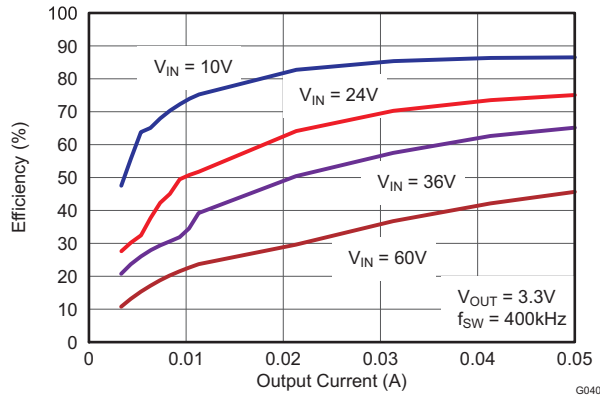

Figure 22. Efficiency vs Output Current

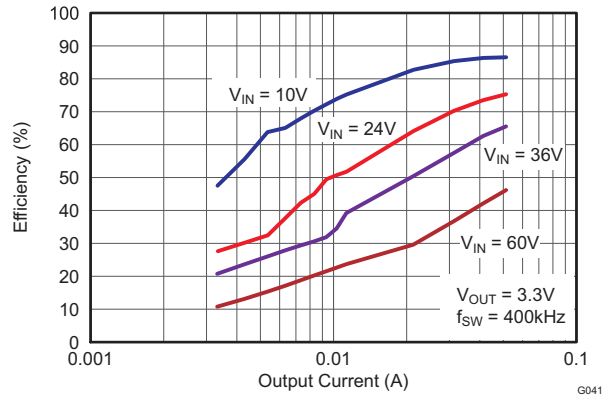

Figure 23. Efficiency vs Output Current

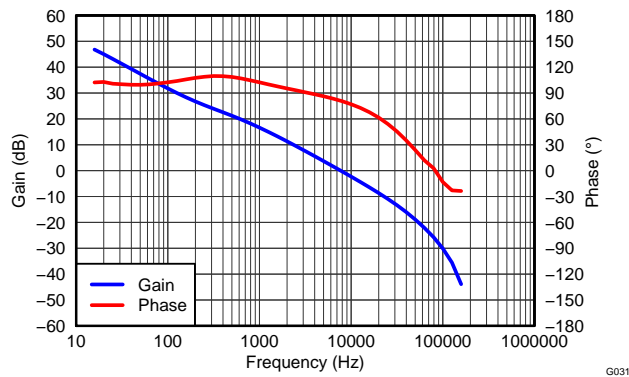

Figure 24. Gain vs Phase

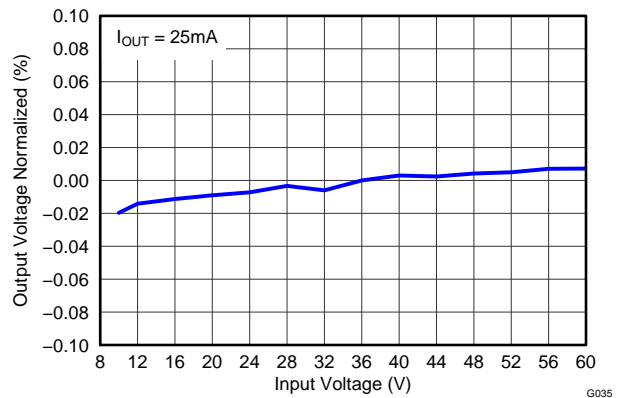

Figure 25. Output Voltage vs Input Voltage

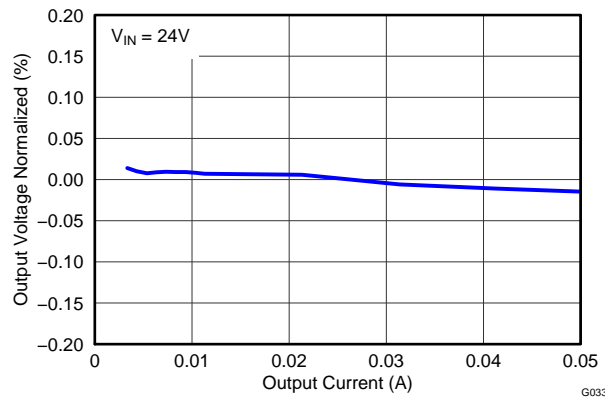

Figure 26. Output Voltage vs Output Current

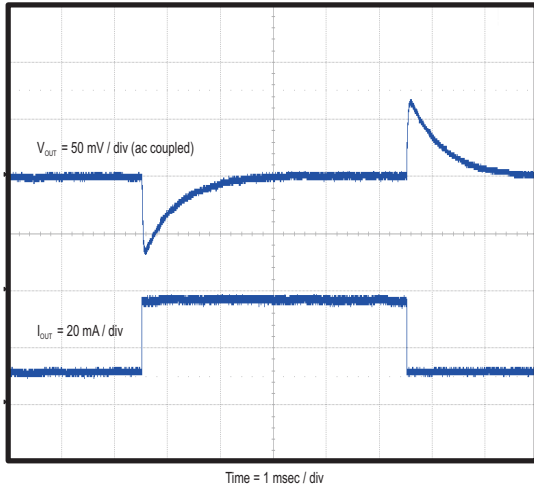

Figure 27. Load Transient

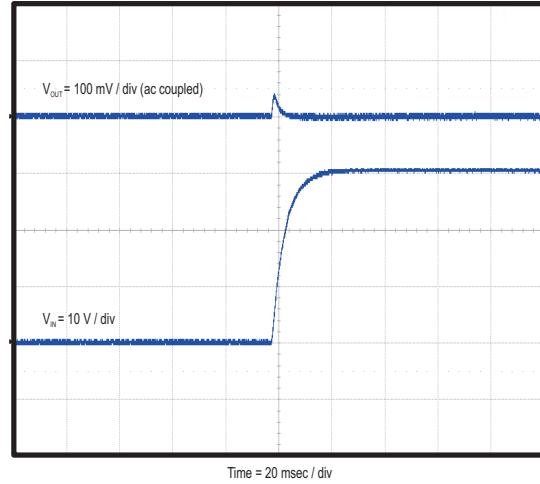

Figure 28. Line Transient

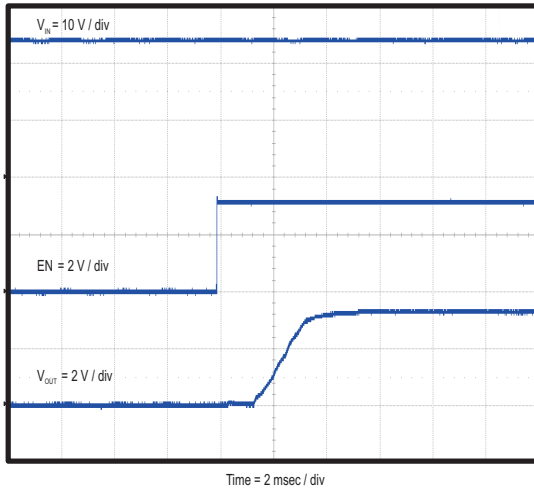

Figure 29. Startup with ENA

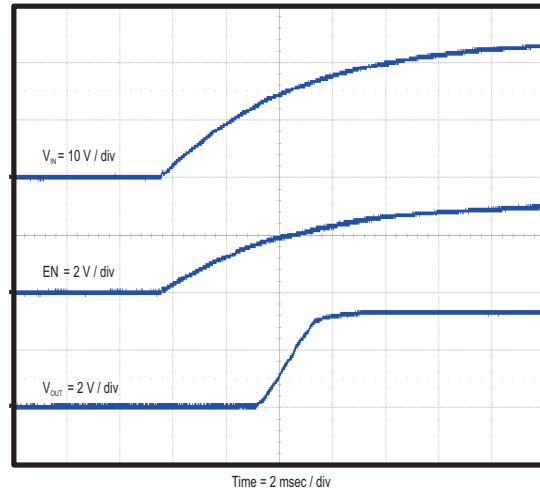

Figure 30. Startup with V_{IN}

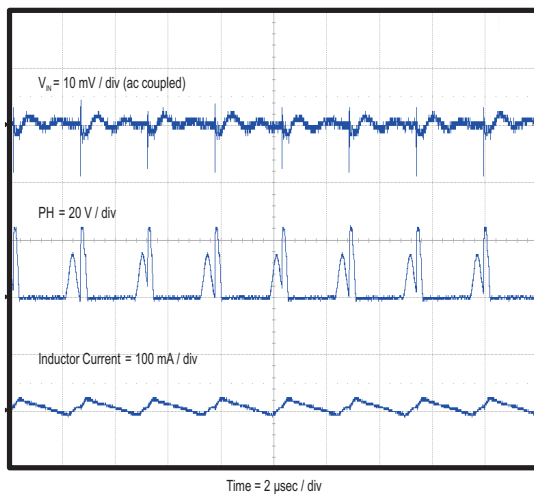

Figure 31. Input Ripple in DCM

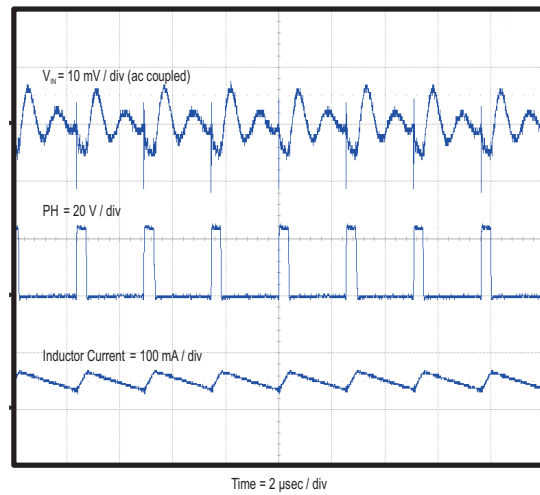

Figure 32. Input Ripple in CCM

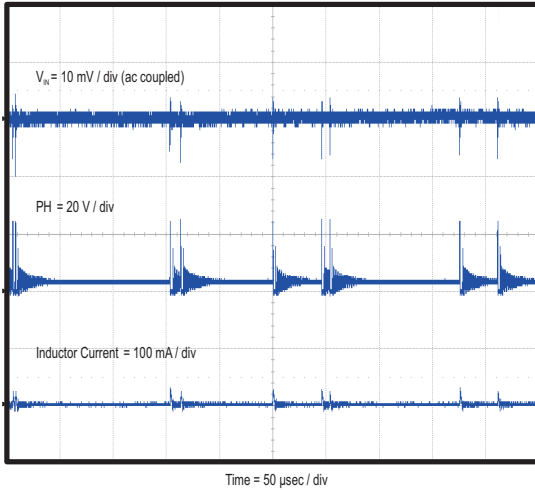

Figure 33. Input Ripple Skip

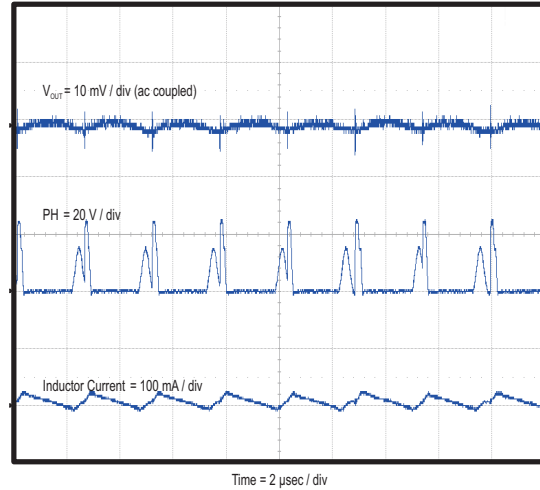

Figure 34. Output Ripple in DCM

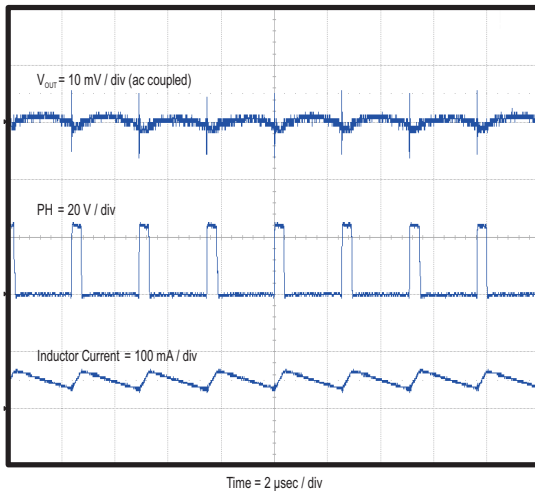

Figure 35. Output Ripple in CCM

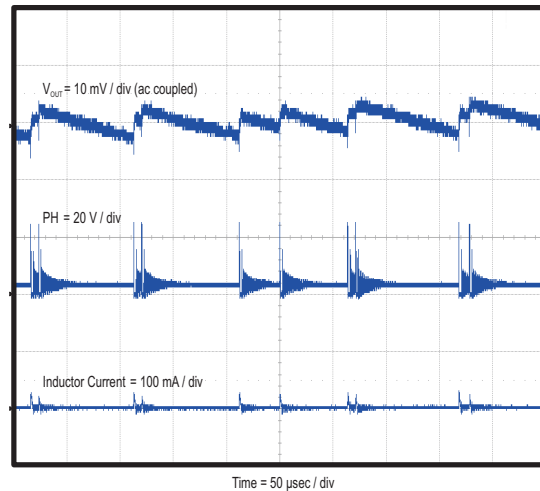
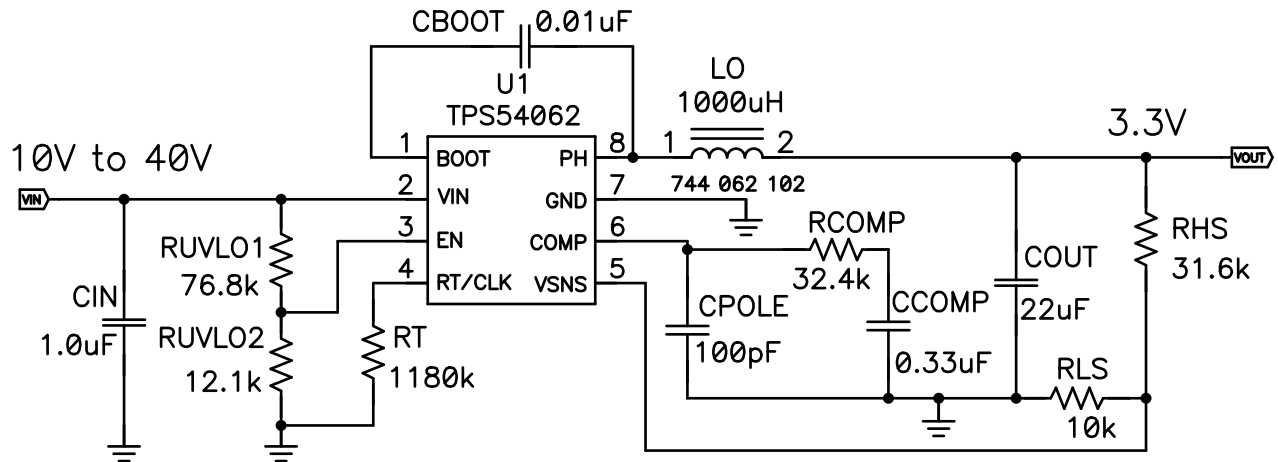

Figure 36. Output Ripple Skip

DESIGN GUIDE – STEP-BY-STEP PROCEDURE Number 2

Figure 37. DCM Application Schematic
For Designing an Efficient, Low Output Current Power Supply at a Fixed Switching Frequency

This example details the design of a low output current, fixed switching regulator design using ceramic output capacitors. A few parameters must be known in order to start the design process. These parameters are typically determined at the system level. For this example, we will start with the following known parameters:

| | |
|--|------------------------|
| Output Voltage | 3.3V |
| Transient Response 0 to 15mA load step | $\Delta V_{OUT} = 4\%$ |
| Maximum Output Current | 10mA |
| Minimum Output Current | 3mA |
| Input Voltage | 24V nom. 10V to 40V |
| Output Voltage Ripple | 0.5% of V_{OUT} |
| Switching Frequency | 100kHz |
| Start Input Voltage (rising VIN) | 9V |
| Stop Input Voltage (falling VIN) | 8V |

It is most desirable to have a power supply that is efficient and has a fixed switching frequency at low output currents. A fixed frequency power supply will have a predictable output voltage ripple and noise. Using a traditional continuous conduction mode (CCM) design method to calculate the output inductor will yield a large inductance for a low output current supply. Using a CCM inductor will result in a large sized supply or will affect efficiency from the large dc resistance an alternative is to operate in discontinuous conduction mode (DCM). Use the procedure below to calculate the components values for designing a power supply operating in discontinuous conduction mode. The advantage of operating a power supply in DCM for low output current is the fixed switching frequency, lower output inductance, and lower dc resistance on the inductor. Use the frequency shift and skip equations to estimate the maximum switching frequency.

The TPS54062 is designed for applications which require a fixed operating frequency and low output voltage ripple at low output currents, thus, the TPS54062 does not have a pulse skip mode at light loads. Since the device has a minimum controllable on time, there is an output current at which the power supply will pulse skip. To ensure that the supply does not pulse skip at output current of the application the inductor value will be need to be selected greater than a minimum value. The minimum inductance needed to maintain a fixed switching frequency at the minimum load is calculated to be 0.9mH using [Equation 26](#). Since the equation is ideal and was derived without losses, assume the minimum controllable light load on time, ton_{minII} , is 350ns. To maintain DCM operation the inductor value and output current need to stay below a maximum value. The maximum inductance is calculated to be 1.42mH using [Equation 27](#). A 744062102 inductor from Wurth Elektronik is selected. If CCM operation is necessary, use the previous design procedure.

Use [Equation 28](#), to make sure the minimum current limit on the high side power switch is not exceeded at the maximum output current. The peak current is calculated as 23.9mA and is lower than the 134 mA current limit. To determine the rms current for the inductor and output capacitor, it is necessary to calculate the duty cycle. The duty cycle, D1, for a step down regulator in DCM is calculated in [Equation 29](#). D1 is the portion of the switching cycle the high side power switch is on, and is calculated to be 0.1153. D2 is the portion of the switching cycle the low side power switch is on, and is calculated to be 0.7253.

Using the [Equation 31](#) and [Equation 32](#), the rms current of the inductor and output capacitor are calculated, to be 12.8mA and 7.6mA respectively. Select components that ratings exceed the calculated rms values. Calculate the output capacitance using the [Equation 33](#) to [Equation 35](#) and use the largest value, Vripple is the steady state voltage ripple and deltaV is voltage change during a transient. A minimum of 1.5µF capacitance is calculated. Additional capacitance de-ratings for aging, temperature and dc bias should be factored in which increases this minimum value. For this example, a 22µF 6.3V X7R ceramic capacitor with 5mΩ ESR is used. To have a low output ripple power supply use a low esr capacitor. Use [Equation 36](#) to estimate the maximum esr for the output capacitor. [Equation 37](#) and [Equation 38](#) estimate the rms current and capacitance for the input capacitor. An rms current of 3.7mA and capacitance of 0.2µF is calculated. A 1µF 100V/X7R ceramic is used for this example.

$$L_{Omin} \geq \left(\frac{V_{Smax} - V_O}{V_O} \right) \times \left(\frac{V_{Smax}}{2} \right) \times \frac{t_{onmin}^2}{I_{Omin}} \times f_{SW} \quad (26)$$

$$L_{Omax} \leq \left(\frac{V_{Smin} - V_O}{2} \right) \times \left(\frac{V_O}{V_{Smin}} \right) \times \frac{1}{f_{SW} \times I_O} \quad (27)$$

$$I_{Lpeak} = \left(\frac{2 \times V_O \times I_{Omax} \times (V_{Smax} - V_O)}{V_{Smax} \times L_O \times f_{SW}} \right)^{0.5} \quad (28)$$

$$D1 = \left(\frac{2 \times V_O \times I_O \times L_O \times f_{SW}}{V_S \times (V_S - V_O)} \right)^{0.5} \quad (29)$$

$$D2 = \left(\frac{V_S - V_O}{V_O} \right) \times D1 \quad (30)$$

$$I_{Lrms} = I_{Lpeak} \times \left(\frac{D1 + D2}{3} \right)^{0.5} \quad (31)$$

$$I_{COrms} = I_{Lpeak} \times \left(\left(\frac{D1 + D2}{3} \right) - \left(\frac{D1 + D2}{4} \right)^2 \right)^{0.5} \quad (32)$$

$$C_{O1} \leq \frac{I_{Lpeak}}{V_{RIPPLE}} \times \left(\frac{D1 + D2}{8 \times f_{SW}} \right) \quad (33)$$

$$C_{O2} \geq L_O \times \frac{(I_O^2 - 0^2)}{(V_O + \Delta V)^2 - V_O^2} \quad (34)$$

$$C_{O3} \geq L_O \times \frac{I_O}{\Delta V} \times \frac{1}{f_{CO}} \quad (35)$$

$$R_C \leq \frac{V_{RIPPLE}}{I_{Lpeak}} \quad (36)$$

$$I_{CINrms} = I_{Lpeak} \times \left(\left(\frac{D1}{3} \right) - \left(\frac{D1}{4} \right)^2 \right)^{0.5} \quad (37)$$

$$C_{IN} \geq \frac{I_O}{V_{INRIPPLE}} \times \left(\frac{0.25}{f_{SW}} \right) \quad (38)$$

Closing the Feedback Loop

The method presented here is easy to calculate and includes the effect of the slope compensation that is internal to the device. This method assumes the crossover frequency is between the modulator pole and the esr zero and the esr zero is at least 10 times greater the modulator pole. Once the output components are determined, use the equations below to close the feedback loop. A current mode controlled power supply operating in DCM has a transfer function which has an esr zero and pole as shown in Equation 39. To calculate the current mode power stage gain, first calculate, K_{dcm} , DCM gain, and F_m , modulator gain, in Equation 40 and Equation 41. K_{dcm} and F_m are 26.3 and 1.34 respectively. The location of the pole and esr zero are calculated using Equation 42 and Equation 43. The pole and zero are 67 Hz and 2 MHz, respectively. Use the lower value of Equation 44 and Equation 45 as a starting point for the crossover frequency. Equation 44 is the geometric mean of the power stage pole and the esr zero and Equation 45 is the mean of power stage pole and the switching frequency. The crossover frequency is chosen as 2.5 kHz from Equation 45.

To determine the compensation resistor, R_{COMP} , use Equation 46. Assume the power stage transconductance, g_{mps} , is 0.65 A/V. The output voltage, V_O , reference voltage, V_{REF} , and amplifier transconductance, g_{mea} , are 3.3V, 0.8V and 102 μ A/V, respectively. R_{COMP} is calculated to be 32.7k Ω , use the nearest standard value of 32.4k Ω . Use Equation 47 to set the compensation zero to the modulator pole frequency. Equation 47 yields 139nF for compensating capacitor C_{COMP} , a 330nF is used on the board. Use the larger value of Equation 48 or Equation 49 to calculate the C_{POLE} , to set the compensation pole. Equation 49 yields 98 pF so the nearest standard of 100 pF is used.

$$G_{dcm}(s) \approx F_m \times K_{dcm} \times \frac{1 + \frac{s}{2 \times \pi \times f_{ZERO}}}{1 + \frac{s}{2 \times \pi \times f_{POLE}}} \quad (39)$$

$$K_{dcm} = \frac{2}{D1} \times \frac{V_O \times (V_S - V_O)}{V_S \times \left(2 + \frac{R_{dc}}{\frac{V_O}{I_O}} \right) - V_O} \quad (40)$$

$$F_m = \frac{g_{mps}}{\left(\frac{V_S - V_O}{L_O \times f_{SW}} \right) + 0.277} \quad (41)$$

$$f_{POLE}(\text{Hz}) = \frac{1}{\frac{V_O}{I_O} \times C_O \times 2 \times \pi} \times \left(\frac{2 - \frac{V_O}{V_S}}{1 - \frac{V_O}{V_S}} \right) \quad (42)$$

$$f_{ZERO}(\text{Hz}) = \frac{1}{R_C \times C_O \times 2 \times \pi} \quad (43)$$

$$f_{CO1}(\text{Hz}) = (f_{ZERO} \times f_{POLE})^{0.5} \quad (44)$$

$$f_{CO2}(\text{Hz}) = (f_{SW} \times f_{POLE})^{0.5} \quad (45)$$

$$R_{COMP} = \frac{f_{CO}}{K_{dcm} \times F_m \times f_{POLE}} \times \frac{V_O}{V_{REF} \times g_{mea}} \quad (46)$$

$$C_{COMP} = \frac{1}{2 \times \pi \times R_{COMP} \times K_{dcm} \times F_m} \quad (47)$$

$$C_{POLE1} = \frac{R_C \times C_O}{R_{COMP}} \quad (48)$$

$$C_{POLE2} = \frac{1}{R_{COMP} \times f_{SW} \times \pi} \quad (49)$$

Characteristics

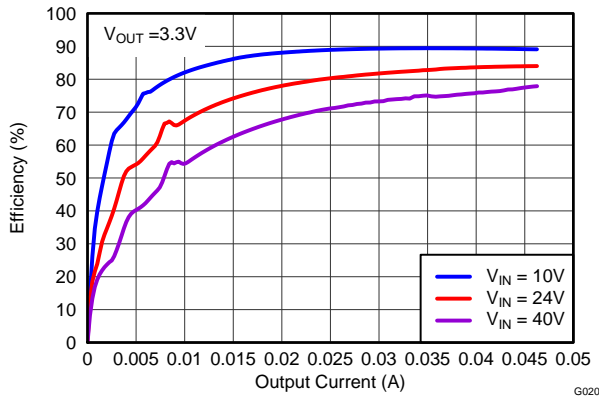

Figure 38. Efficiency vs Output Current

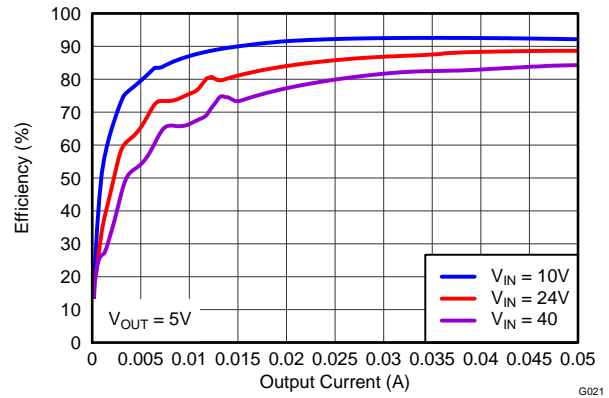

Figure 39. Efficiency vs Output Current

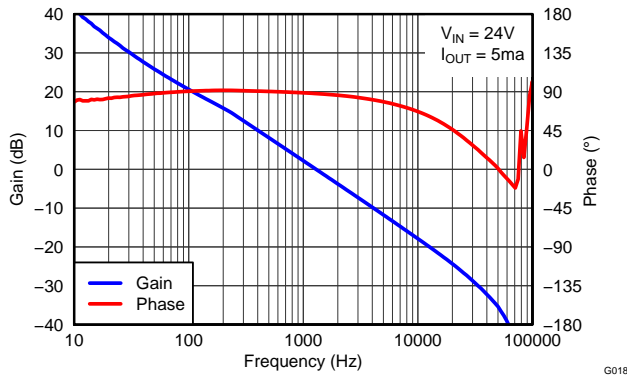

Figure 40. Gain vs Phase

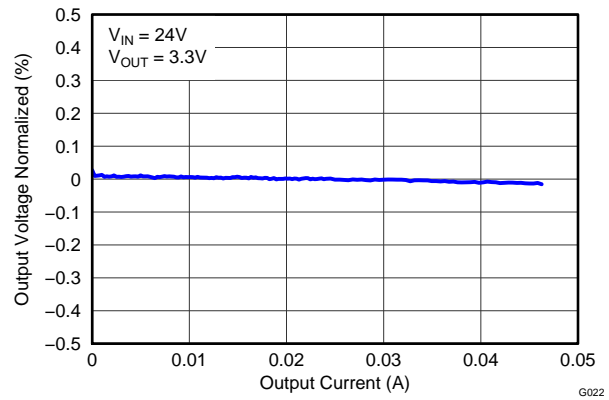

Figure 41. Output Voltage vs Output Current

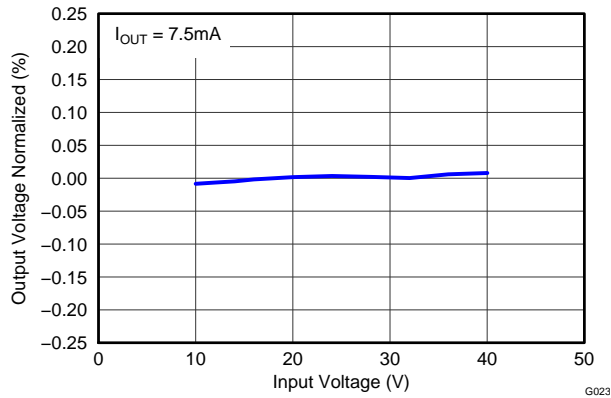

Figure 42. Output Voltage vs Input Voltage

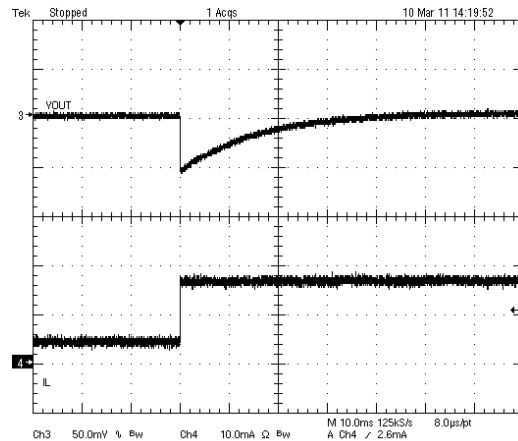

Figure 43. Load Transient

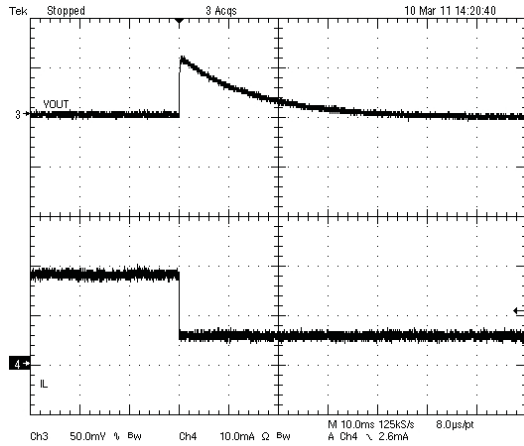

Figure 44. Unload Transient

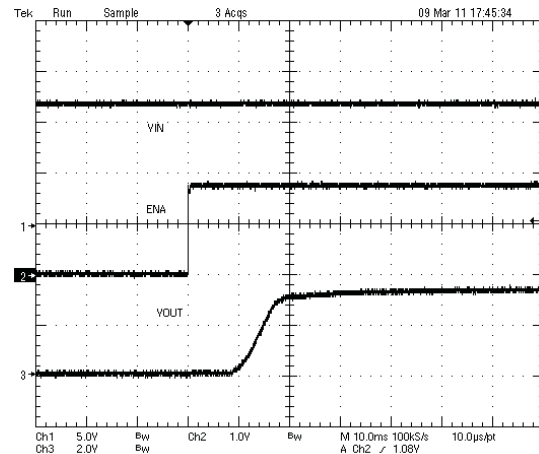

Figure 45. Startup With ENA

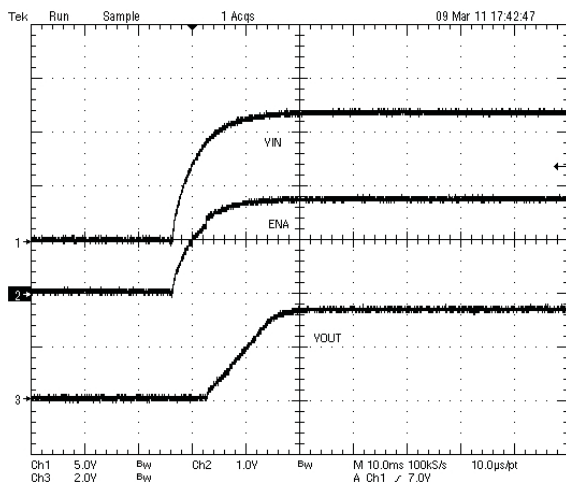

Figure 46. Startup With V_{IN}

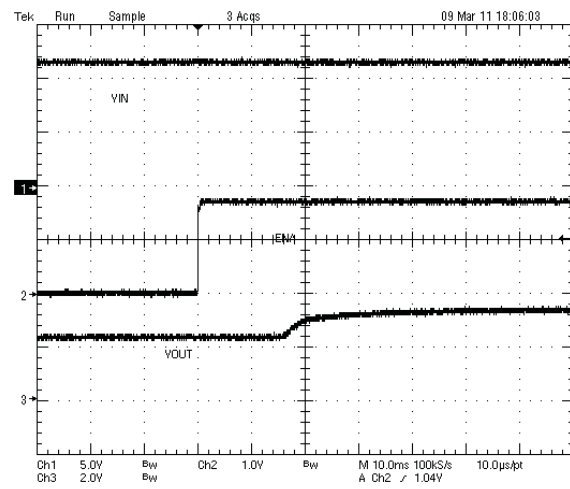

Figure 47. Prebias Startup With ENA

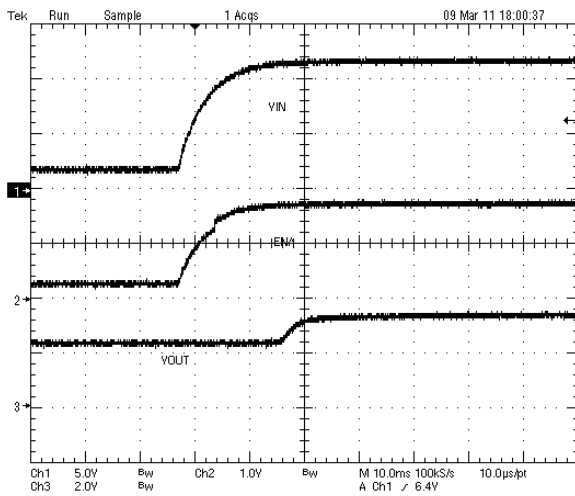

Figure 48. Prebias Startup With V_{IN}

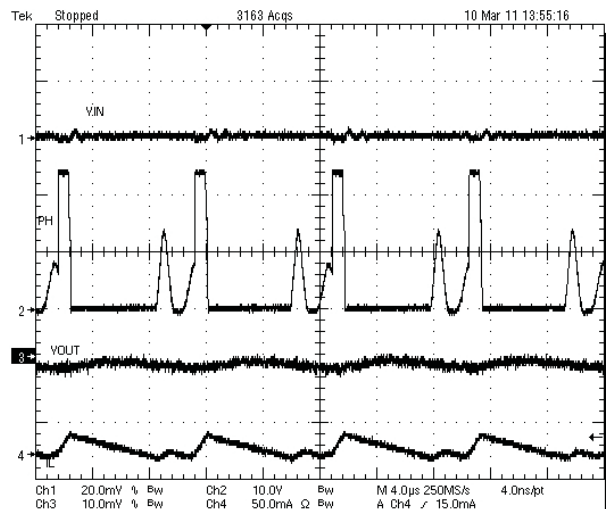

Figure 49. Input and Output Ripple in DCM

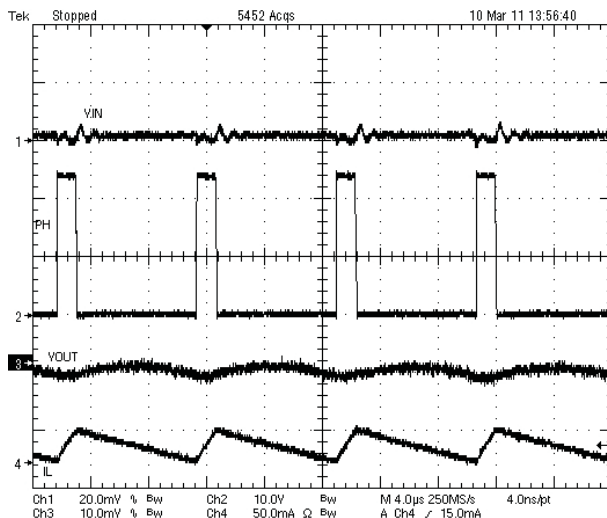

Figure 50. Input and Output Ripple in CCM

Layout

Layout is a critical portion of good power supply design. There are several signals paths that conduct fast changing currents or voltages that can interact with stray inductance or parasitic capacitance to generate noise or degrade the power supplies performance. To help eliminate these problems, the VIN pin should be bypassed to ground with a low ESR ceramic bypass capacitor with X5R or X7R dielectric. Care should be taken to minimize the loop area formed by the bypass capacitor connections, the VIN pin, and the GND pin. See for a PCB layout example. Since the PH connection is the switching node and output inductor should be located close to the PH pins, and the area of the PCB conductor minimized to prevent excessive capacitive coupling. The RT/CLK pin is sensitive to noise, so the RT resistor should be located as close as possible to the IC and routed with minimal lengths of trace. The additional external components can be placed approximately as shown. It may be possible to obtain acceptable performance with alternate PCB layouts; however, this layout has been shown to produce good results and is meant as a guideline.

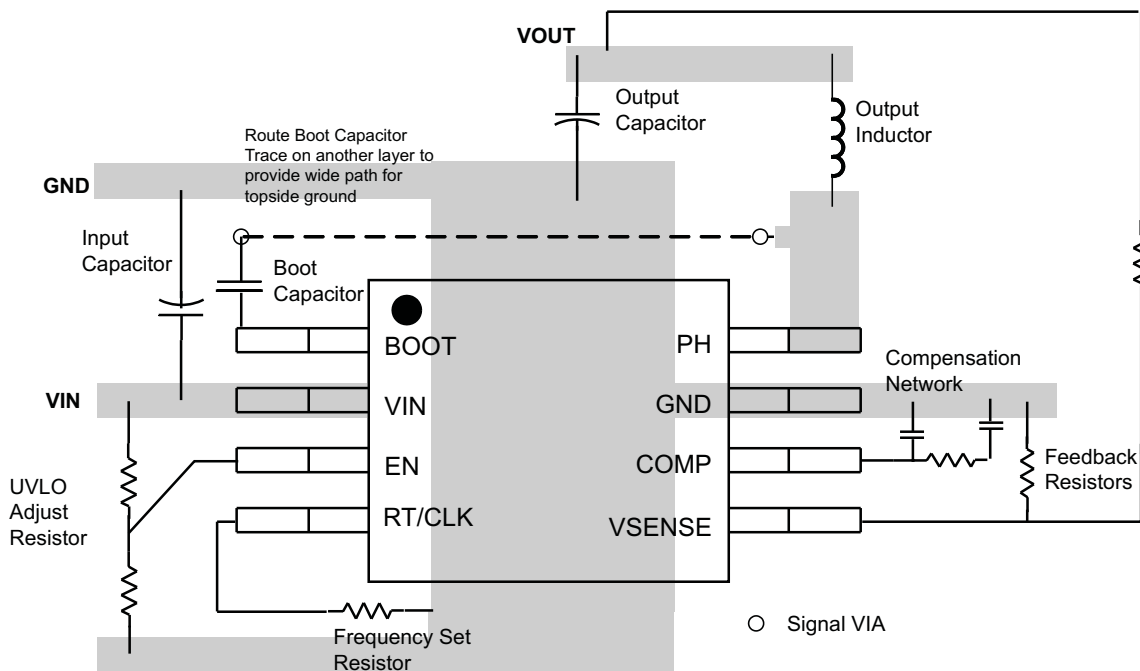

Figure 51. PCB Layout Example

PACKAGING INFORMATION

| Orderable Device | Status ⁽¹⁾ | Package Type | Package Drawing | Pins | Package Qty | Eco Plan ⁽²⁾ | Lead/ Ball Finish | MSL Peak Temp ⁽³⁾ | Samples (Requires Login) |
|------------------|-----------------------|--------------|-----------------|------|-------------|----------------------------|----------------------|------------------------------|-----------------------------|
| TPS54062DGKR | ACTIVE | MSOP | DGK | 8 | 2500 | Green (RoHS & no Sb/Br) | CU NIPDAU | Level-2-260C-1 YEAR | |

⁽¹⁾ The marketing status values are defined as follows:

ACTIVE: Product device recommended for new designs.

LIFEBUY: TI has announced that the device will be discontinued, and a lifetime-buy period is in effect.

NRND: Not recommended for new designs. Device is in production to support existing customers, but TI does not recommend using this part in a new design.

PREVIEW: Device has been announced but is not in production. Samples may or may not be available.

OBSOLETE: TI has discontinued the production of the device.

⁽²⁾ Eco Plan - The planned eco-friendly classification: Pb-Free (RoHS), Pb-Free (RoHS Exempt), or Green (RoHS & no Sb/Br) - please check <http://www.ti.com/productcontent> for the latest availability information and additional product content details.

TBD: The Pb-Free/Green conversion plan has not been defined.

Pb-Free (RoHS): TI's terms "Lead-Free" or "Pb-Free" mean semiconductor products that are compatible with the current RoHS requirements for all 6 substances, including the requirement that lead not exceed 0.1% by weight in homogeneous materials. Where designed to be soldered at high temperatures, TI Pb-Free products are suitable for use in specified lead-free processes.

Pb-Free (RoHS Exempt): This component has a RoHS exemption for either 1) lead-based flip-chip solder bumps used between the die and package, or 2) lead-based die adhesive used between the die and leadframe. The component is otherwise considered Pb-Free (RoHS compatible) as defined above.

Green (RoHS & no Sb/Br): TI defines "Green" to mean Pb-Free (RoHS compatible), and free of Bromine (Br) and Antimony (Sb) based flame retardants (Br or Sb do not exceed 0.1% by weight in homogeneous material)

⁽³⁾ MSL, Peak Temp. -- The Moisture Sensitivity Level rating according to the JEDEC industry standard classifications, and peak solder temperature.

Important Information and Disclaimer: The information provided on this page represents TI's knowledge and belief as of the date that it is provided. TI bases its knowledge and belief on information provided by third parties, and makes no representation or warranty as to the accuracy of such information. Efforts are underway to better integrate information from third parties. TI has taken and continues to take reasonable steps to provide representative and accurate information but may not have conducted destructive testing or chemical analysis on incoming materials and chemicals. TI and TI suppliers consider certain information to be proprietary, and thus CAS numbers and other limited information may not be available for release.

In no event shall TI's liability arising out of such information exceed the total purchase price of the TI part(s) at issue in this document sold by TI to Customer on an annual basis.

DGK (S-PDSO-G8)

PLASTIC SMALL-OUTLINE PACKAGE



4073329/E 05/06

- NOTES:
- A. All linear dimensions are in millimeters.
 - B. This drawing is subject to change without notice.
 - C. Body length does not include mold flash, protrusions, or gate burrs. Mold flash, protrusions, or gate burrs shall not exceed 0.15 per end.
 - D. Body width does not include interlead flash. Interlead flash shall not exceed 0.50 per side.
 - E. Falls within JEDEC MO-187 variation AA, except interlead flash.

IMPORTANT NOTICE

Texas Instruments Incorporated and its subsidiaries (TI) reserve the right to make corrections, modifications, enhancements, improvements, and other changes to its products and services at any time and to discontinue any product or service without notice. Customers should obtain the latest relevant information before placing orders and should verify that such information is current and complete. All products are sold subject to TI's terms and conditions of sale supplied at the time of order acknowledgment.

TI warrants performance of its hardware products to the specifications applicable at the time of sale in accordance with TI's standard warranty. Testing and other quality control techniques are used to the extent TI deems necessary to support this warranty. Except where mandated by government requirements, testing of all parameters of each product is not necessarily performed.

TI assumes no liability for applications assistance or customer product design. Customers are responsible for their products and applications using TI components. To minimize the risks associated with customer products and applications, customers should provide adequate design and operating safeguards.

TI does not warrant or represent that any license, either express or implied, is granted under any TI patent right, copyright, mask work right, or other TI intellectual property right relating to any combination, machine, or process in which TI products or services are used. Information published by TI regarding third-party products or services does not constitute a license from TI to use such products or services or a warranty or endorsement thereof. Use of such information may require a license from a third party under the patents or other intellectual property of the third party, or a license from TI under the patents or other intellectual property of TI.

Reproduction of TI information in TI data books or data sheets is permissible only if reproduction is without alteration and is accompanied by all associated warranties, conditions, limitations, and notices. Reproduction of this information with alteration is an unfair and deceptive business practice. TI is not responsible or liable for such altered documentation. Information of third parties may be subject to additional restrictions.

Resale of TI products or services with statements different from or beyond the parameters stated by TI for that product or service voids all express and any implied warranties for the associated TI product or service and is an unfair and deceptive business practice. TI is not responsible or liable for any such statements.

TI products are not authorized for use in safety-critical applications (such as life support) where a failure of the TI product would reasonably be expected to cause severe personal injury or death, unless officers of the parties have executed an agreement specifically governing such use. Buyers represent that they have all necessary expertise in the safety and regulatory ramifications of their applications, and acknowledge and agree that they are solely responsible for all legal, regulatory and safety-related requirements concerning their products and any use of TI products in such safety-critical applications, notwithstanding any applications-related information or support that may be provided by TI. Further, Buyers must fully indemnify TI and its representatives against any damages arising out of the use of TI products in such safety-critical applications.

TI products are neither designed nor intended for use in military/aerospace applications or environments unless the TI products are specifically designated by TI as military-grade or "enhanced plastic." Only products designated by TI as military-grade meet military specifications. Buyers acknowledge and agree that any such use of TI products which TI has not designated as military-grade is solely at the Buyer's risk, and that they are solely responsible for compliance with all legal and regulatory requirements in connection with such use.

TI products are neither designed nor intended for use in automotive applications or environments unless the specific TI products are designated by TI as compliant with ISO/TS 16949 requirements. Buyers acknowledge and agree that, if they use any non-designated products in automotive applications, TI will not be responsible for any failure to meet such requirements.

Following are URLs where you can obtain information on other Texas Instruments products and application solutions:

Products

| | |
|-----------------------------|--|
| Audio | www.ti.com/audio |
| Amplifiers | amplifier.ti.com |
| Data Converters | dataconverter.ti.com |
| DLP® Products | www.dlp.com |
| DSP | dsp.ti.com |
| Clocks and Timers | www.ti.com/clocks |
| Interface | interface.ti.com |
| Logic | logic.ti.com |
| Power Mgmt | power.ti.com |
| Microcontrollers | microcontroller.ti.com |
| RFID | www.ti-rfid.com |
| RF/IF and ZigBee® Solutions | www.ti.com/lprf |

Applications

| | |
|-------------------------------|--|
| Communications and Telecom | www.ti.com/communications |
| Computers and Peripherals | www.ti.com/computers |
| Consumer Electronics | www.ti.com/consumer-apps |
| Energy and Lighting | www.ti.com/energy |
| Industrial | www.ti.com/industrial |
| Medical | www.ti.com/medical |
| Security | www.ti.com/security |
| Space, Avionics and Defense | www.ti.com/space-avionics-defense |
| Transportation and Automotive | www.ti.com/automotive |
| Video and Imaging | www.ti.com/video |
| Wireless | www.ti.com/wireless-apps |

TI E2E Community Home Page

e2e.ti.com

Mailing Address: Texas Instruments, Post Office Box 655303, Dallas, Texas 75265
Copyright © 2011, Texas Instruments Incorporated